

**Urovo**

# **Mobile Computer**

## **DT50P**

### **User Guide**



**Urovo Technology Co., Ltd.**

*Note:* \_\_\_\_\_

- \* This Guide introduced general functions of DT50P. Your PDA device may have different functions wherein or description.
  - \* There may be differences between the illustrations in this Guide and the actual product. And the actual product shall prevail.
-



## *Terms of usage*

### *Statement*

*This Guide includes proprietary information of Shenzhen Urovo Technology Co., Ltd. Its purpose is to help users better operate, use and maintain the device described herein only. Without written permit of Urovo, the proprietary information in the text shall not be copied or disclosed to any other party.*

### *Product improvement*

*Urovo will keep improving its products but give no further notice in case of any change in the specification or design.*

### *Disclaimer*

*All the user guides and specifications published by Urovo are correct. In the event of any wrong information, Urovo shall reserve the right to correct such errors but waive rights of liability and claim.*

*Urovo shall not be liable for personal and property safety of users in the following cases:*

- *User or any third party delegated fails to transport or store the battery in the correct way specified in this Guide;*
- *The battery used by the user is not purchased from any official channel of Urovo;*

## Table of Contents

|                                                   |    |
|---------------------------------------------------|----|
| About the Guide.....                              | 7  |
| Chapter 1 Getting Started .....                   | 10 |
| 1.1 Unpacking.....                                | 10 |
| 1.2 Appearance.....                               | 11 |
| 1.2.1 Front Side .....                            | 11 |
| 1.2.2 Side.....                                   | 11 |
| 1.2.3 Back Side .....                             | 13 |
| 1.3 Installation Guide .....                      | 13 |
| 1.3.1 Instruction of battery .....                | 13 |
| 1.3.2 Instruction of battery replacement.....     | 14 |
| 1.3.3 Instruction on SIM/TF Card replacement..... | 14 |
| 1.4 Caution on Battery Charging.....              | 15 |
| 1.5 Charging Method.....                          | 15 |
| 1.5.1 Charge by USB.....                          | 15 |
| 1.5.2 Charge by desktop charger.....              | 16 |
| 1.6 Battery Optimization .....                    | 17 |
| 1.7 Usage of Touchscreen .....                    | 17 |
| Chapter 2 Device settings.....                    | 19 |
| 2.1 Access device settings.....                   | 19 |
| 2.2 WLAN.....                                     | 20 |
| 2.3 WWAN .....                                    | 23 |
| 2.4 Bluetooth .....                               | 23 |
| 2.5 Display .....                                 | 25 |

|                                                       |    |
|-------------------------------------------------------|----|
| 2.5.1 Screen Rotation Settings.....                   | 25 |
| 2.5.2 Sleep Settings.....                             | 25 |
| 2.6 Sound Settings.....                               | 26 |
| 2.7 Privacy Settings.....                             | 27 |
| 2.8 Date and Time Settings .....                      | 29 |
| 2.9 Reset Settings .....                              | 30 |
| 2.10 About Devices .....                              | 31 |
| 2.11 Scan Settings.....                               | 32 |
| 2.11.1 Floating action button .....                   | 32 |
| 2.11.2 Triggering Mode .....                          | 32 |
| 2.11.4 Keystroke output .....                         | 33 |
| 2.11.5 Reader Params .....                            | 35 |
| 2.11.6 Basic data formatting .....                    | 38 |
| 2.12 ScanWedge Profiles.....                          | 40 |
| 2.13 Feature Settings .....                           | 42 |
| 2.14 Remap Key .....                                  | 43 |
| Chapter 3 Application.....                            | 48 |
| 3.1 Access the application.....                       | 48 |
| 3.2 App Profile .....                                 | 48 |
| 3.3 Enterprise Launcher.....                          | 51 |
| 3.4 U Stage .....                                     | 55 |
| 3.5 WIFI Diagnosis .....                              | 57 |
| 3.6 Description of Computer Connected Operation ..... | 58 |
| 3.6.1 Developer options .....                         | 58 |

|                                                                  |    |
|------------------------------------------------------------------|----|
| 3.6.2 File management by media transfer protocol (MTP) .....     | 60 |
| 3.6.3 Picture management by picture transfer protocol (PTP)..... | 60 |
| 3.6.4 Charging mode .....                                        | 61 |
| 3.6.5 Disconnection from PC .....                                | 62 |
| Charter 4 Accessories .....                                      | 63 |
| 4.1 List of Standard Accessories .....                           | 63 |
| 4.2 List of Optional Accessories.....                            | 63 |
| Chapter 5 Maintenance and Troubleshooting .....                  | 65 |
| 5.1 Maintenance .....                                            | 65 |
| 5.2 Cleaning .....                                               | 65 |
| 5.3 Troubleshooting.....                                         | 66 |

---

## About the Guide

### Introduction

This Guide offers information on usage of DT50P mobile computer and its accessories.

Note: The screens and windows described in this Guide are samples, which can differ from actual ones.

### Software version

To determine the software version of the current device, please touch **Settings -System-About Phone**.

Android Version——display operating system version

Version No.——display software build version number.

### Chapter description

This Guide covers the following topics:

- **Getting Started** offers information on putting DT50P into operation for the first time.
- **Device Setting** describes each setting of DT50P.
- **Applications** describes usage of built-in apps.
- **Accessories** describes information on standard and optional parts.

### Sign convention

The following convention applies in the text:

#### **Bold:**

Emphasis

---

Title

Dialog box, window, part name, and screen icon

Keyword

Button name

(●) :

Operational option

Order list

Step list needed, which may not be continuous

(√) :

Functional option

**Italic:**

Marked emphasis

## **Relevant Document**

- Quick Start Guide for DT50P Handheld Intelligent Terminal
- DT50P Brochure
- DT50P Specification

For the latest edition of this Guide and all the other guides, please visit:

<http://www.urovo.com>

## **Service information**

*You can visit the official website (enurovo.com) of Urovo Technology Co., Ltd. (hereinafter referred to as Urovo) whenever possible to gain quick network support services:*

*Click the search box and enter corresponding product model to query the machine's configuration information. Click maintenance query*



---

*to query information of the nearest service center or enter the serial number (SN) of your device in the search box for maintenance progress to query the maintenance state to follow up the state of the device in maintenance in time! Service hotline: 400-888-6989*

*Please offer the following information while contacting the Support Center:*

- *Device SN (Serial Number)*
- *Model or product name*
- *Software type and version number: check the device "Settings-System-About Phone"*

*Thanks for your cooperation!*

### **Provision of document feedback**

If you have any comment, question or advice on this Guide, please e-mail to [tech@urovo.com](mailto:tech@urovo.com) 或 [service@urovo.com](mailto:service@urovo.com)

---

# Chapter 1 Getting Started

## Introduction

This chapter describes product information and instruction of device for the first time.

## 1.1 Unpacking

- 1 . Please carefully remove all the protective materials around DT50P and keep the device case for storing and transporting the device in the future
2. Please check the following elements:
  - DT50P intelligent terminal×1
  - Adapter×1
  - USB cable×1
  - Quick start guide×1
3. Inspect the device for damage. If any equipment is damaged or missing, please contact the customer service support or local distributor.
4. Please remove the screen shipping protective film before using.

## 1.2 Appearance

### 1.2.1 Front Side

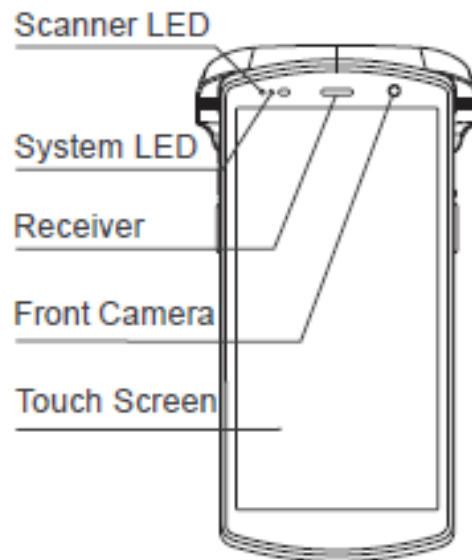

Figure 1-1 Front View

### 1.2.2 Side

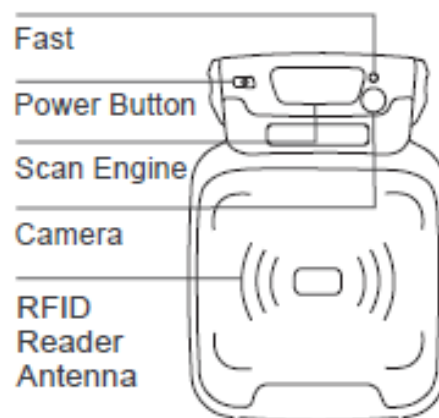

Figure 1-2 Top View

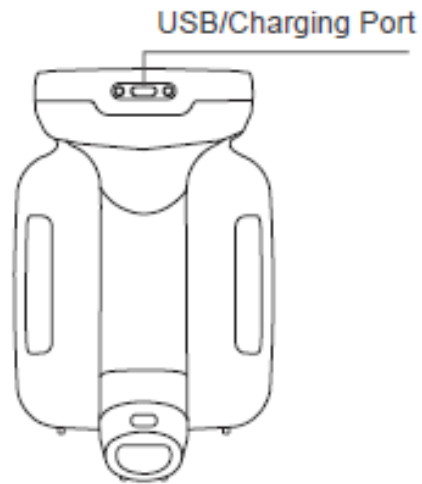

Figure 1-3 Bottom View

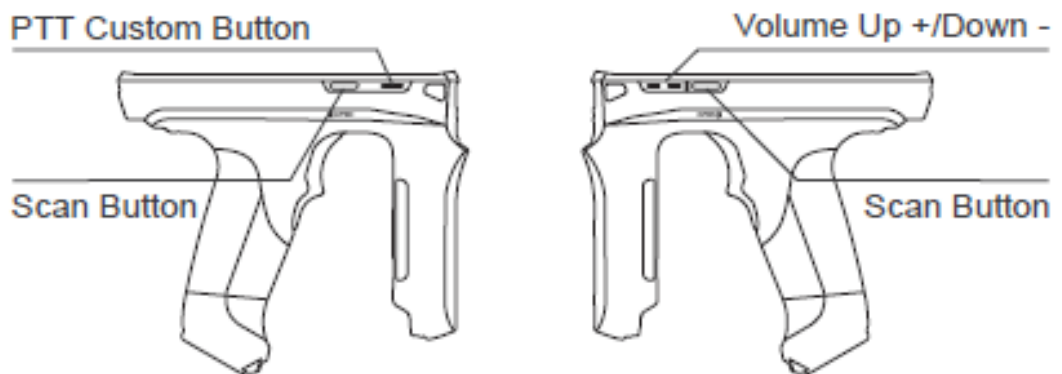

Figure 1-4 Left & Right-Side Views

## 1.2.3 Back Side

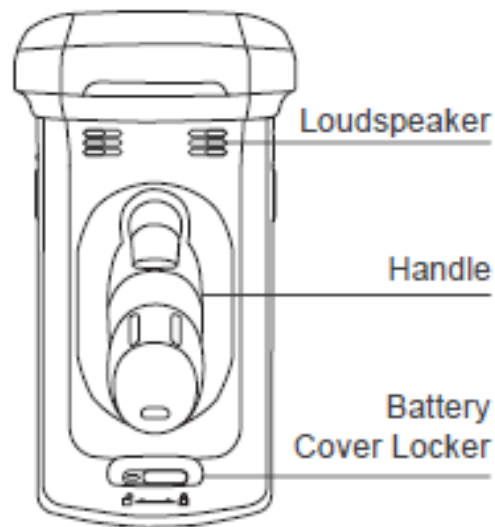

Figure 1-5 Back View

## 1.3 Installation Guide

### 1.3.1 Instruction of battery

While installing the battery, please note the direction of installing the battery. Load the front end of the battery in the device's battery slot and push the bottom of the battery into the device. Please do not push the battery into the device with force. The installed battery in the battery holder should be flat and secure. The installation method is as shown in Figure 6 .

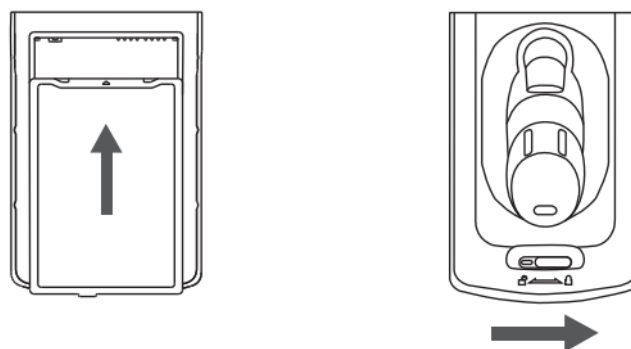

Figure 1-6 Battery Installation

After installing the battery cover, turn the battery cover fastener right to the lock position.

### 1.3.2 Instruction of battery replacement

1. Long press the power key and a dialog box will pop up;
2. Select power-off;
3. Upon power-off, turn the battery cover fastener left and remove the battery cover;
4. Lift the battery from its tail end to remove and replace the battery with a new one.

### 1.3.3 Instruction on SIM/TF Card replacement

1. Long press the power key and a dialog box will pop up;
2. Select power-off;
3. Upon power-off, turn the battery cover fastener left and remove the battery cover;
4. Lift the battery from its tail end to remove the battery;
5. Manually pull out the SIM/TF Card holder in the left of the shell to remove the SIM/TF Card;
6. Push a new SIM/TF Card into the holder to replace the former one. A slight click will indicate that the installation is completed.

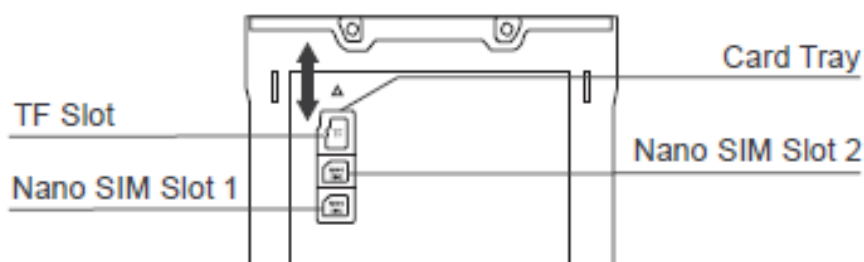

Figure 1-7 DT50P Card Slot

## 1.4 Caution on Battery Charging

1. Please do not use or charge the device in any environment with too high or low temperature;
2. Please charge the battery by the product's charger in standard configuration or desktop charger only;
3. If the device (including the battery) is not used for the moment, please separately store the battery and device and pack them in PE bags or other insulated bags in the original package in case that they become damp or contact with other electronic devices. Do not store the unpacked battery in a stack;
4. Please do not idle the device for over 3 months; be sure to charge and discharge the battery not used for the moment once per 3 months, where the stored battery should be 60% ~ 70% charged (i.e., 3.8V ~ 3.9V);
5. The lithium battery should be stored somewhere cool, dry and ventilated. It is advised to be stored in a 0 ~ 28°C environment.

## 1.5 Charging Method

### 1.5.1 Charge by USB

For Type-C USB cable, link one end to computer and the other to device. In charging, the device's charge indicator is red, which will turn green when the device is fully charged.



Figure 1-8 Type-C USB Cable

## 1.5.2 Charge by desktop charger

desktop charger can charge the device (including the battery) and a battery at the same time.



Figure 1-9 Power Adapter to Desktop Charger

1. Connect the DC interface of the base to the power adapter;
2. Load the front end of the battery into the battery slot and push the bottom of the battery into the battery slot to complete battery installation.
3. Put the back of the device body in the body slot of the base. And in this case, If the device indicator is on red, charging is underway.



Figure 1-10 Charge by desktop charger



---

## 1.6 Battery Optimization

Please follow the tips below to save the battery power:

- Clear the background of all apps to enter the power-saving mode
- In Settings-Automatic On/Off, set DT50P to automatically power on/off.
- Reduce screen brightness.
- Turn off all the wireless connections not used for the moment. Touch the airplane mode. The airplane icon will be shown in the status bar, indicating that all the wireless connections are off.
- Turn off automatic updates of e-mail, calendar, contacts and other apps.

## 1.7 Usage of Touchscreen

Use the multi-touch-sensitive screen to operate the device.

- **Light touch - light touch to:**

- Select any screen option;

- Enter letters and signs in the screen keyboard;

- Press any screen button.

- **Light touch press and hold - light touch, press and hold to:**

- Create a home screen shortcut for a certain App;

- Open the home screen menu for user-defined home screen settings;

- Blank out the home screen till the menu is seen;

- Drag - light touch, press for a short time and hold a certain option, and finger the option in the screen to a new position.

- **Slide - slide to:**

- Slide up/down or left/right in the app center interface to browse different app icons;

- Slide in the lock-screen interface to set the unlocking pattern to unlock the screen.

---

- **Long press - long press to:**

Long press the home screen to call the MENU function;

Drag any app or tool shortcut.

# Chapter 2 Device settings

## 2.1 Access device settings

### Method 1

Pull down the status bar to open the quick access panel, then tap the settings icon.

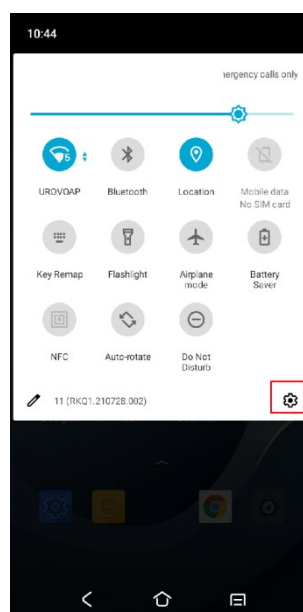

Figure 2-1 quick access panel

### Method 2

In the home screen, pull up the screen to enter the app center interface, then tap the settings icon.

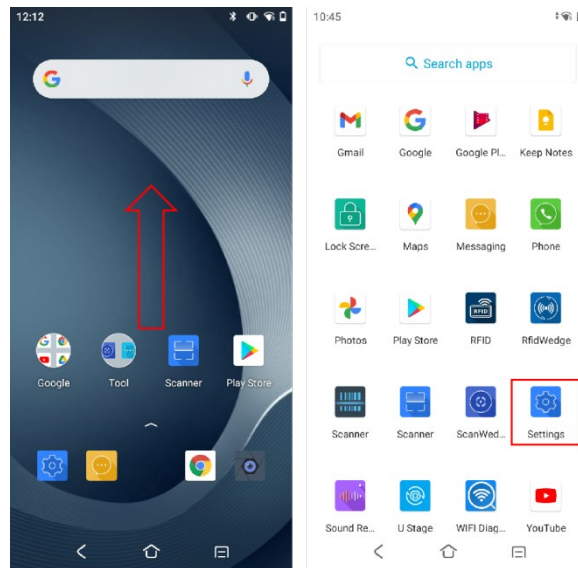

Figure 2-2 app center interface

## 2.2 WLAN

To enable the WLAN function, please operate as following:

After the wireless function is enabled, DT50P will automatically display all the available wireless networks nearby in the wireless network list. To connect to a certain wireless network, please click the network's SSID in the list and tap **CONNECT**.

*Note: For some networks, network security key or password needs to be entered for connecting. To connect to such networks, please contact the network admin for corresponding network security keys or passwords.*

1. Open "**Settings-Network & internet**" or pull down the status bar to enter the quick access panel for operation;
2. Tap **Wi-Fi**, then turn on **Use Wi-Fi** switch, touch to select the network you will connect to;

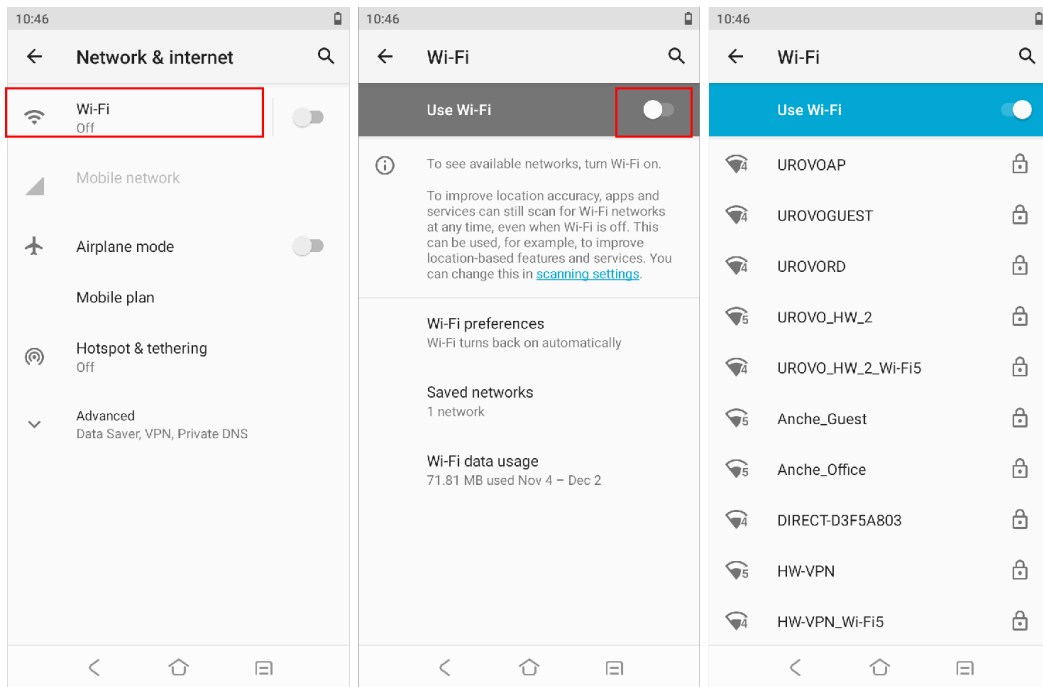

Figure 2-3 Wi-Fi Option Bar

3. Enter the password and tap "**CONNECT**";

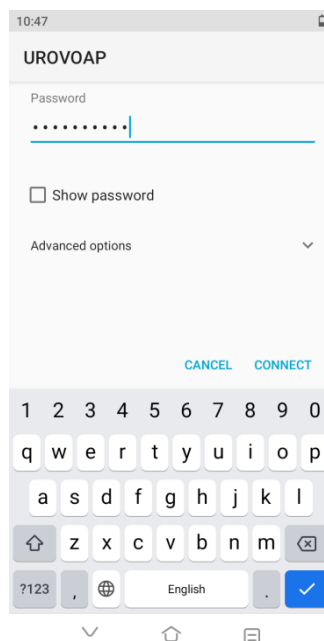

Figure 2-4 Wi-Fi Password and Settings Input Box

- Check **Show password** to display the hotspot password to check whether the password input is wrong;

- **Check Advanced options** for advanced settings, including agent and static IP settings.

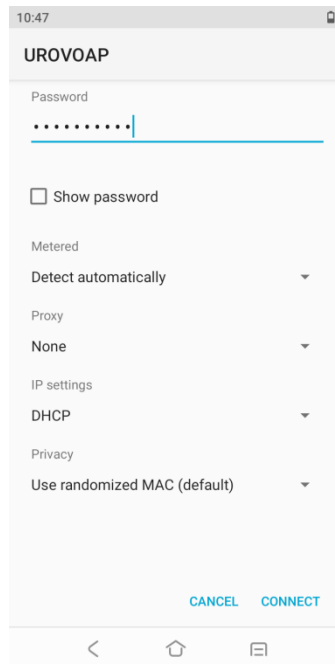

Figure 2-5 Wi-Fi Static IP Settings

4. Check whether connection is done: 'Connected' indicates that connection is done, Click the network to view the network details;

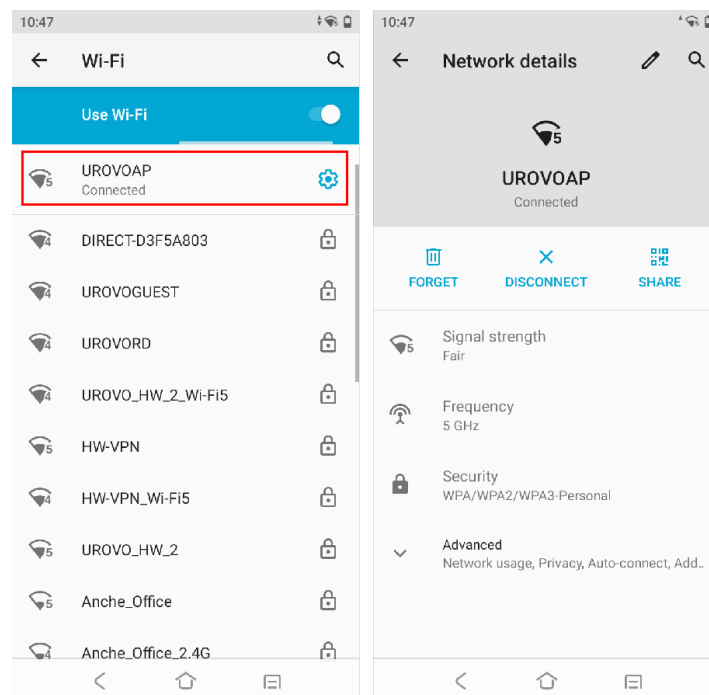

Figure 2-6 Wi-Fi Connected

---

## 2.3 WWAN

Please refer to "Instruction on SIM/TF Card installation" for how to insert a SIM Card.

Open "**Settings-Network & internet-Mobile network**" , to set the mobile network in conjunction with carrier information settings, such as data on/off, roaming on/off, and access point name, etc.

DT50P supports a wide range of 4G networks . If failed to connect to WWAN, please follow as below:

1. Check local network signal intensity
2. Check whether the SIM Card is correctly installed;
3. Check whether the SIM Card has any pending bill, is available for surfing the Internet or damaged (test whether the SIM Card is damaged or has any pending bill by loading the SIM Card in the device);
4. Check whether the access point is correctly set.

## 2.4 Bluetooth

Device with the Bluetooth function such as printer, access point and other mobile computer can exchange data (e.g., file, date or task) after turning on the Bluetooth function.

DT50P supports BLE (Bluetooth low energy). BLE is oriented to healthcare, health, safety and home entertainment apps. It remains a standard Bluetooth coverage while reducing power consumption and saving cost.

To enable Bluetooth connectivity, please follow as below:

1. Pull down the status bar and long press the Bluetooth icon or click "**Settings-Connected devices**" to enter the page;
2. Tap **Pair new devices** to search for Bluetooth devices nearby;

3. Tap **Device name** can change visible name to another;

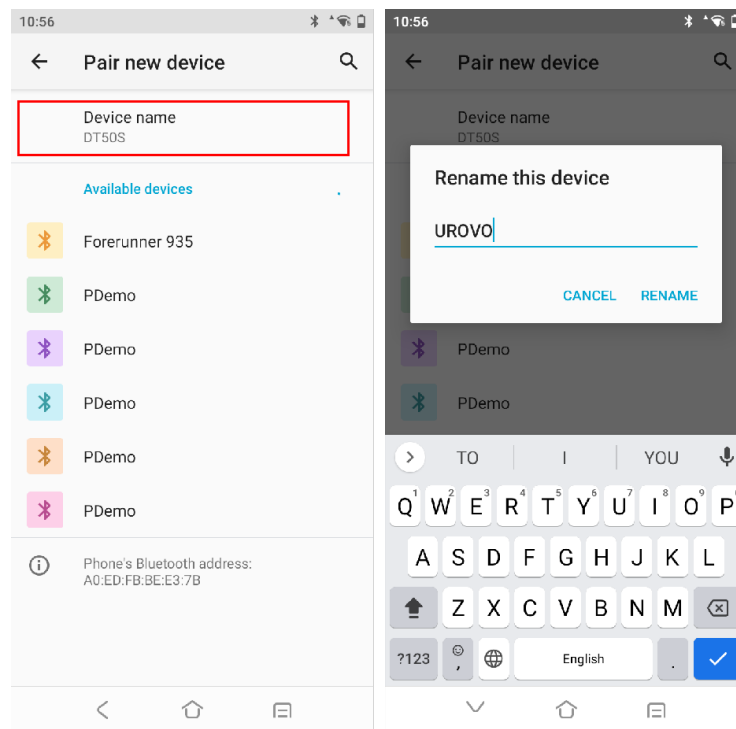

Figure 2-7 Bluetooth settings

4. Tap the device to be connected and enter PIN code for verifying pairing or request for entering PIN code.

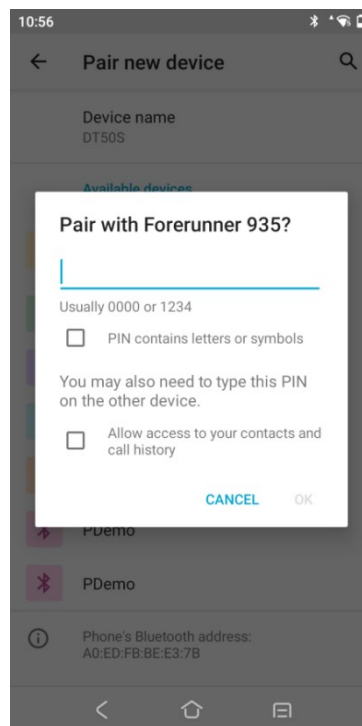

Figure 2-8 Bluetooth Pairing



---

## 2.5 Display

The Display Settings adjustable **Brightness level**, **Dark theme**, change **Wallpaper**, set **Auto-rotate screen**, set **Screen timeout** and **Font size** and other functions.

### 2.5.1 Screen Rotation Settings

By default, screen rotation is disabled. To enable screen rotation, please follow as below:

- a) Pull down the status bar and click the screen rotation icon;
- b) Check **Settings-Display-Auto-rotate screen**;



Auto-rotate

- Keep the current orientation: lock the orientation;
- Orientation of screen rotation: rotate subject to screen content.

Note: rotation is not available for the home screen interface.

### 2.5.2 Sleep Settings

User may make DT50P sleep if not using it for a moment. As DT50P is in the sleep status, user may directly press the power key to wake up the screen and unlock to back to the program interface. To make DT50P sleep, press the power key to turn off the screen or set sleep time. please follow as below:

1. Touch the settings icon to enter settings;
2. Open **“Display-Screen timeout”** ;

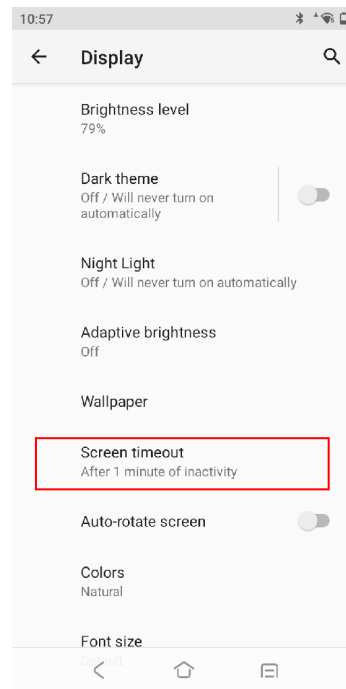

Figure 2-9 Screen timeout

3. Select a sleep time

## 2.6 Sound Settings

To adjust the volume of the device, please follow as below:

1. Press the volume key to regulate media volume settings. Slide up or down the volume icon to set the volume;
2. Click the settings icon to open the sound settings interface for setting media volume, call volume, ringer volume, and alarm volume as well as ringtone, alarm tone, etc.;

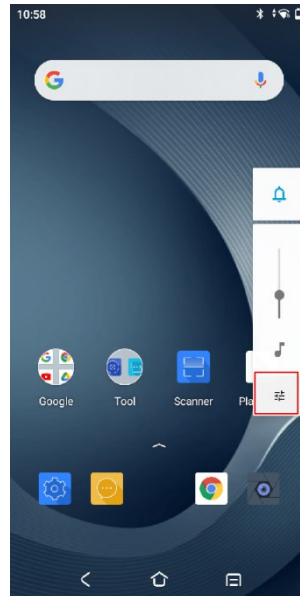

Figure 2-10 Media Volume Settings

3. Select Settings-Sound to open the sound settings interface for setting the media volume, call volume, ringer volume, alarm volume as well as ringtone, alarm tone, other notification tones, or vibration, etc.

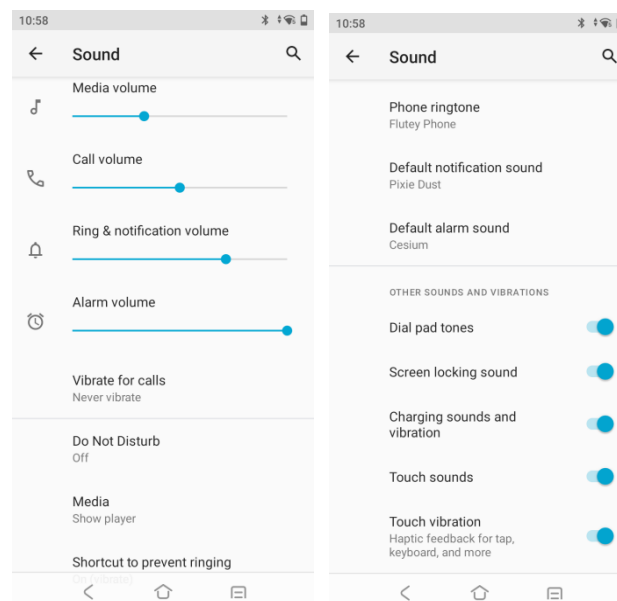

Figure 2-11 Sound Settings

## 2.7 Privacy Settings

To view and change the permissions for your application, please follow as bellow:

1. Open **“Settings-Privacy-Permission manager”** ;

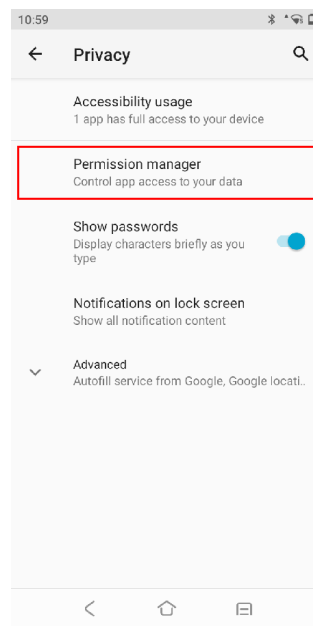

Figure 2-12 Privacy Setting page

2. Click the permissions you want to view or modify (take SMS permissions as an example);

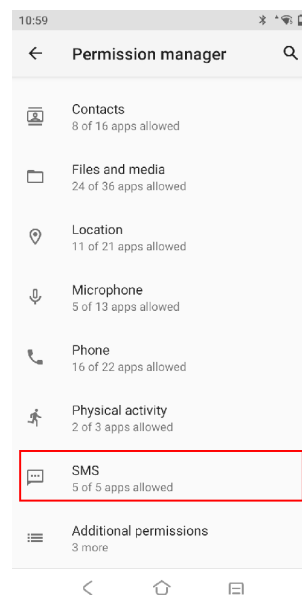

Figure 2-13 Permission manager

3. You can view the applications that have been allowed or denied this permission and click the application you want to modify;

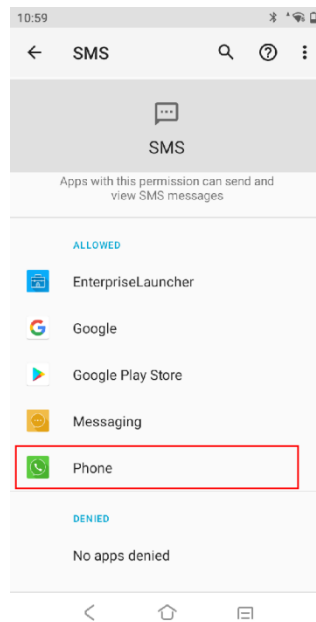

Figure 2-14 SMS Permissions

4. You can modify whether the application allows SMS permission.

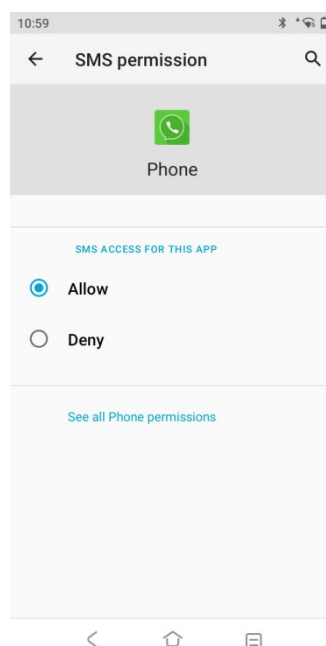

Figure 2-15 SMS permission

## 2.8 Date and Time Settings

As DT50P is networked, the system will automatically update the time and date. Users need set the time zone only. If time is not updated,

please check whether the device is networked or whether the current WLAN supports the network time protocol (NTP).

Where manual settings are needed, please take the following steps:

1. Open **“Settings-System-Date & time”** ;
2. Disable **Use network-provided time**;
3. Modify time and back.

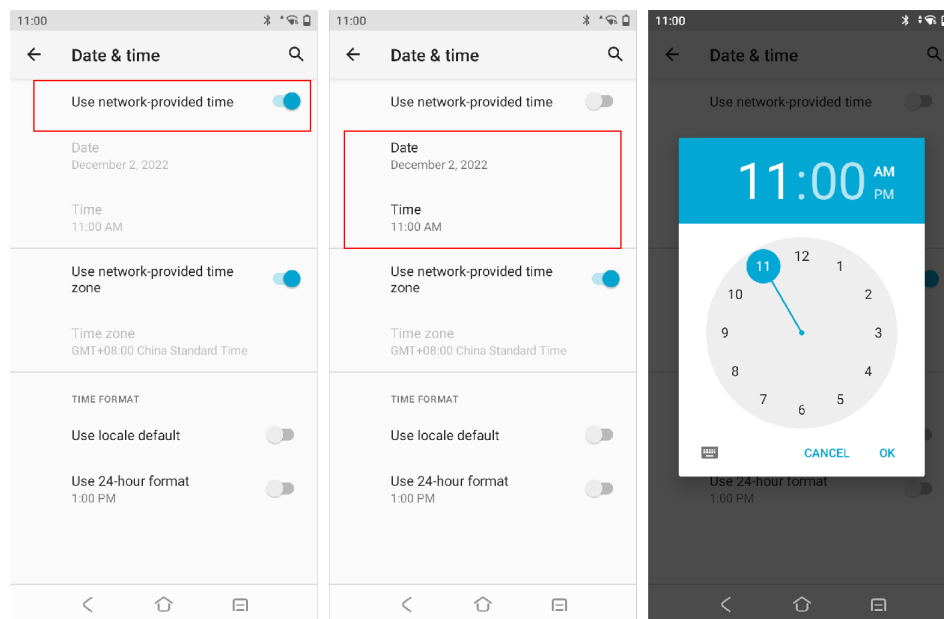

Figure 2-16 System Time Settings

## 2.9 Reset Settings

*Restore Device is a built-in restoration toolkit that enables users to initialize the system. Attention! Please copy and save important files before resetting! Restoration will erase all the user data!*

1. Pull down the status bar to open the quick access panel;
2. Tap the settings icon to enter **“Settings-System-Advanced-Reset options”** ;
3. Select:
  - Reset Wi-Fi, mobile Data Network and Bluetooth
  - Reset app preferences

- Erase All Data (factory reset)

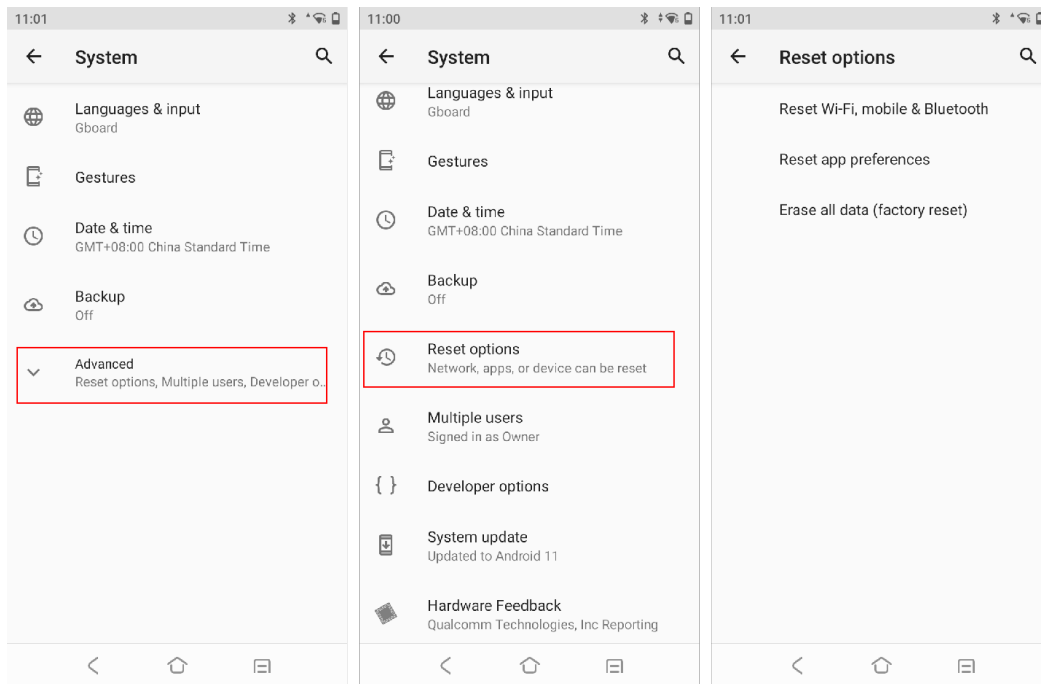

Figure 2-17 Reset options

## 2.10 About Devices

Open **"Settings>About phone"** , to view information of this Terminal Device.

**SIM status**—view carrier, signal strength, IMEI and other information

**Device ID**—display the device's unique identifier

**Model**—view the device's model and SN

**IMEI**—view IMEI1, IMEI2 and MEID information

**Android version**—view the device's Android version

**IP address**—display the device's IP address

**Wi-Fi MAC address**—display the device's WIFI physical address

**Bluetooth address**—display the device's Bluetooth address

## 2.11 Scan Settings

*Scanning engine may differ from each other in the settings interface. N6603 is taken as example for illustration herein. For more details, please contact Urovo's technical staff for instruction.*

### 2.11.1 Floating action button

**Suspension button:** Open the virtual key scanning tool on the desktop--USCAN, which is available for dragging at will and touching to simulate the key scanning function;

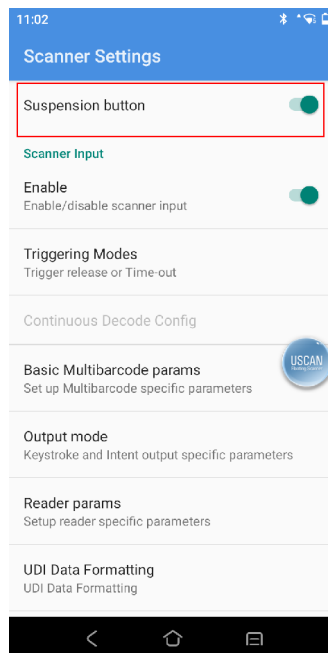

Figure 2-18 Floating Button Scanning Function

### 2.11.2 Triggering Mode

- **Auto mode-Decode or Time-out:** manually trigger the scanning function. Press the scanning key and laser light or supplementary light will be shown. The light will not go out until decoding is completed or scanning times out;
- **Continuous mode-KeyDown start, Again KeyDown stop:** manually trigger the scanning function. In the continuous scanning mode, the



scanning laser or supplementary image light will not go out after decoding. Instead, decoding will sustain;

- Manual mode-**Trigger release or Time-out** : manually trigger the scanning function. Press the scanning key and laser light or supplementary light will be shown. Release the key and the light will go out. In addition, the scanning light will also go out after decoding;

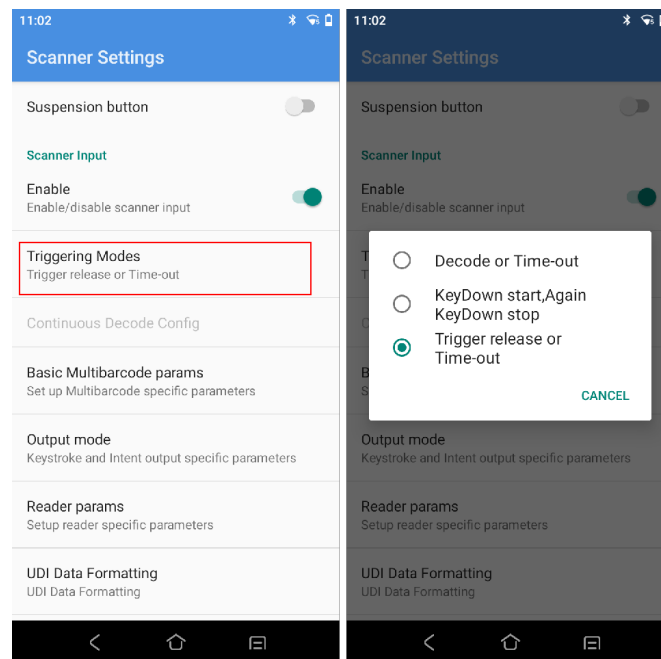

Figure 2-19 Triggering Mode

## 2.11.4 Keystroke output

Check this mode and the scanning results will be output to the app focus edit box in the foreground by keyboard.

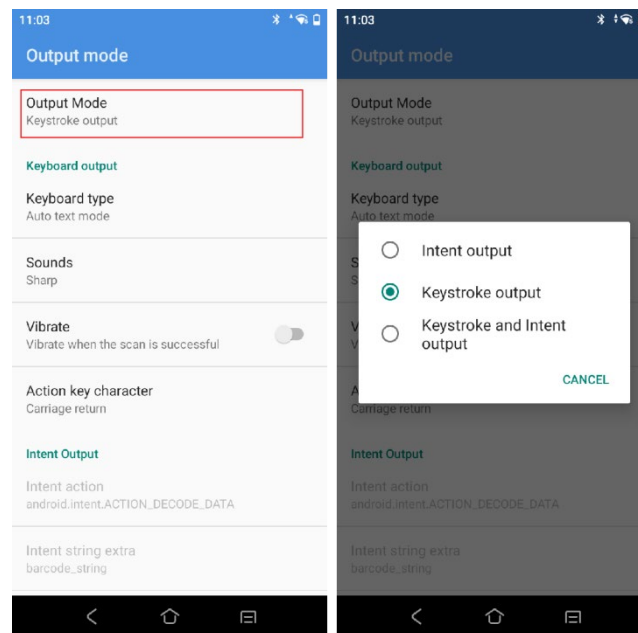

Figure 2-20 keystroke output

- ✓ **Keyboard type** – options include **Auto text mode**, **Soft keyboard**, **Always Physical keyboard**, Such options may cause a difference in scanning results. Please select with caution.

**Auto text mode:** If a focus input box arises in any app interface in the foreground, it will directly show all the data, otherwise the device will output scanning results character by character through keyboard simulation;

**Soft keyboard:** the device directly displays all the data in the input box through input method editor simulation;

**Always Physical keyboard:** the device outputs scanning data through physical key event simulation at any interface;

- ✓ **Sounds** – set the system's notification tone for scanning, which may be None, Instant (default) or Squeak.
- ✓ **Vibrate** – check to enable the function of vibrating after scanning

- ✓ **Action key character** – **None**, **Carriage return**, **Line feed**, **Tab**, Add operational key characters behind scanning results through keyboard simulation.

**None:** no operation

**Carriage return:** add an enter behind scanning results through keyboard simulation;

**Line feed:** add an OK operation behind scanning results through keyboard simulation;

**Tab:** add a Tab key operation behind scanning results through keyboard simulation;

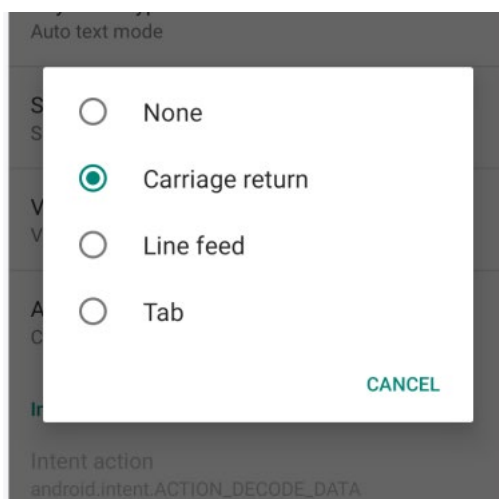

Figure 2-21 Action key character

## 2.11.5 Reader Params

**Coding format:** The Chinese code type is UTF-8 by default. This option needs to correspond to the Chinese code type of 2D codes. Any mismatch between the two may lead to code garbling. Please use this function with care.

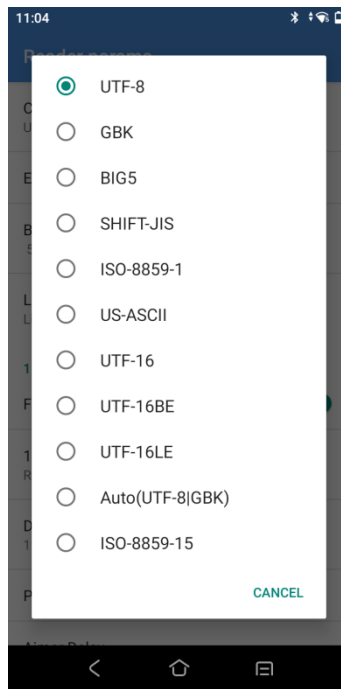

Figure 2-22 Chinese Code Type

**Beam timer** – laser duration for failing in single scanning, range of 500-10000ms, 5000 ms by default;

**Linear code type security level** – set the check level to lower the error rate. The higher the level is, the more accurate it will be but the slower decoding per time will be;

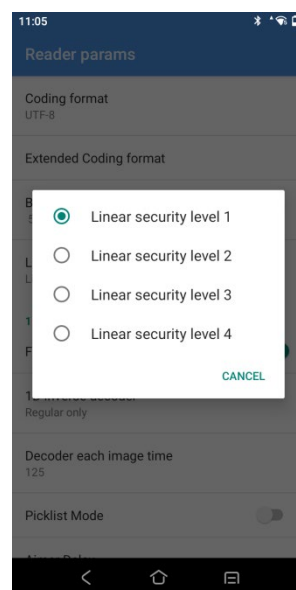

Figure 2-23 Linear code type security level

## Exposure Settings-Lights Configuration

**Illum/Aimer Off:** turn off illumination / aimer light;

**Aimer Only:** turn on aim light only;

**Illum Only:** turn on illumination only;

**Alternating:** turn on illumination and aim light in alternation;

**Concurrent:** turn on illumination and aim light at the same time;

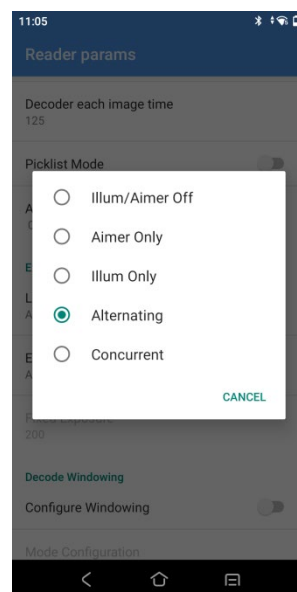

Figure 2-24 Lights Configuration

- ✓ **Exposure Mode:** auto/on. In the auto mode, the scanning engine may automatically regulate the exposure value; in the on mode, the exposure value can be set;

**Fixed Exposure:** 1~900, The higher the value is, the brighter it will be;

## 2.11.6 Basic data formatting

Upon access of bar codes, the system may be available for additional functions: Formatting, Prefix, Suffix, Formatting, Substitute, Delete Non-printing Control Character, App Identifier, or Code Id Type.

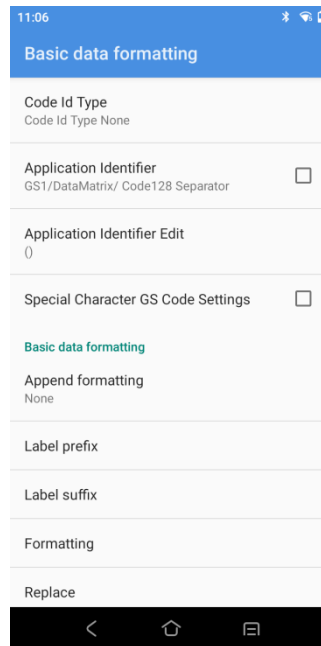

Figure 2-25 Basic data formatting

1. Tap Label Formatting and select the additional formatting type;

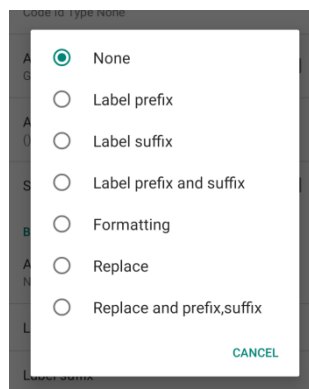

Figure 2-26 Append formatting settings

2. Suffix: select the mode and modify the suffix content, e.g., select [CR] which indicates enter;

The same goes for prefix;

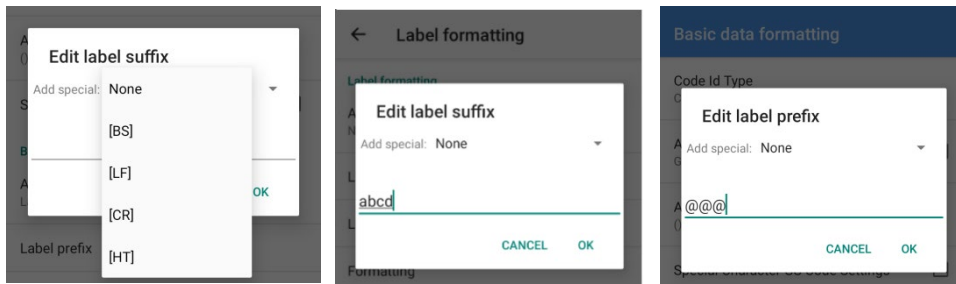

Figure 2-27 Edit Suffix/prefix

Select the default type from the drop-down list box or define any character as the prefix/suffix;

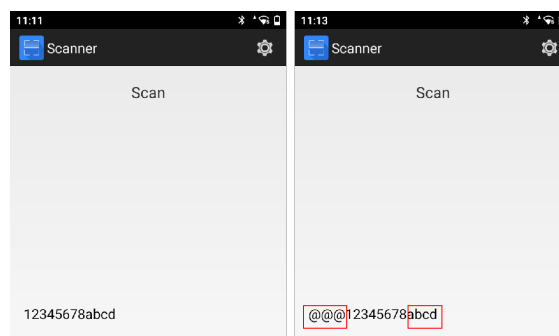

Figure 2-28 Edit Suffix/prefix

3. **Replace:** select the mode and modify the former character to be substituted and the substitute character and set the value of the substituted and that of substitute. The former character needs to be input in ASCII code (e.g., if the former character "1" needs to be substituted, enter its corresponding ASCII code value "31");

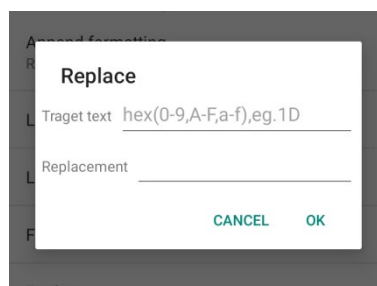

Figure 2-29 Edit Replace

4. **Delete Non-printing Control Character:** select the mode and delete any nondisplay character;

5. App Identifier: select the mode and add an app identifier to some bar codes, e.g., Code 128;
6. App Delimited Identifier: select the mode and set "()" as the app delimited identifier by default, which may be substituted by any other identifier;
7. Code Id Type: select the mode and add a Code Id (Code Id Type None, Code Id Type Aim (add an Aim in front bar codes) or Code Id Type Symbol (add an identifier in front of bar codes)) to some bar codes;

## 2.12 ScanWedge Profiles

ScanWedge Profiles allows to modify the default scan settings and to create new scan settings.

1. Click **Default** to modify the scan settings for the default application.

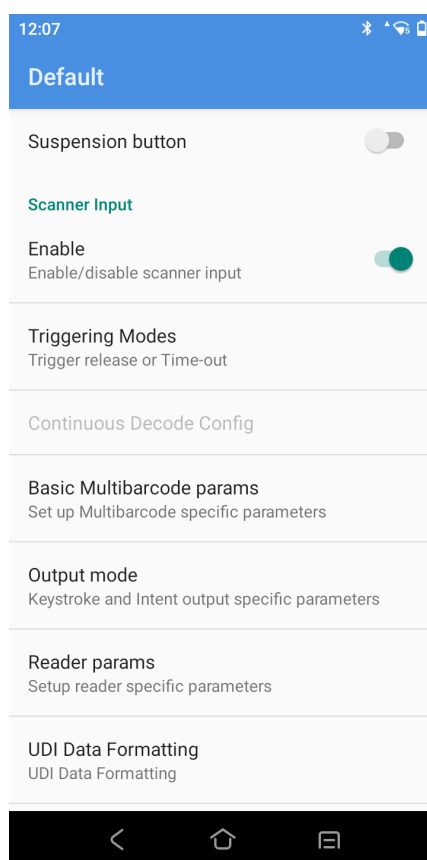
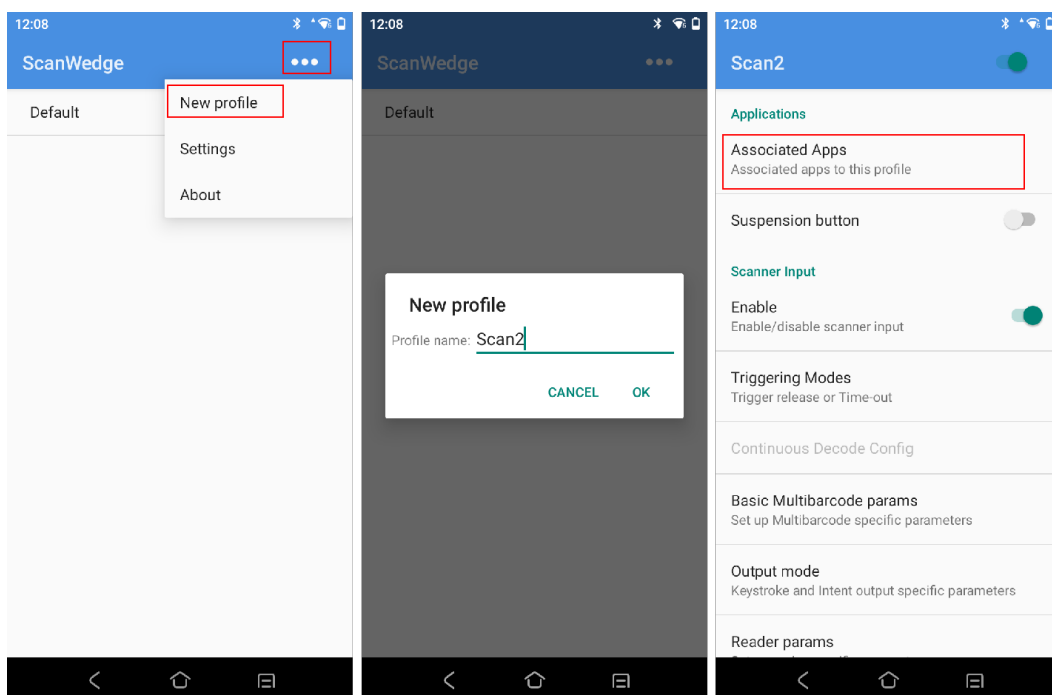

Figure 2-30 Scan Default Settings Page



2. New scan settings can be created and applications can be associated to this profile, as follows:

- (a) Click on the top right option and select "**New profile**";
- (b) Name the new scan configuration;
- (c) Touch "**Associated Apps**" ;
- (d) Touch "**Associate more app**";
- (e) Select the app you want to associate with.



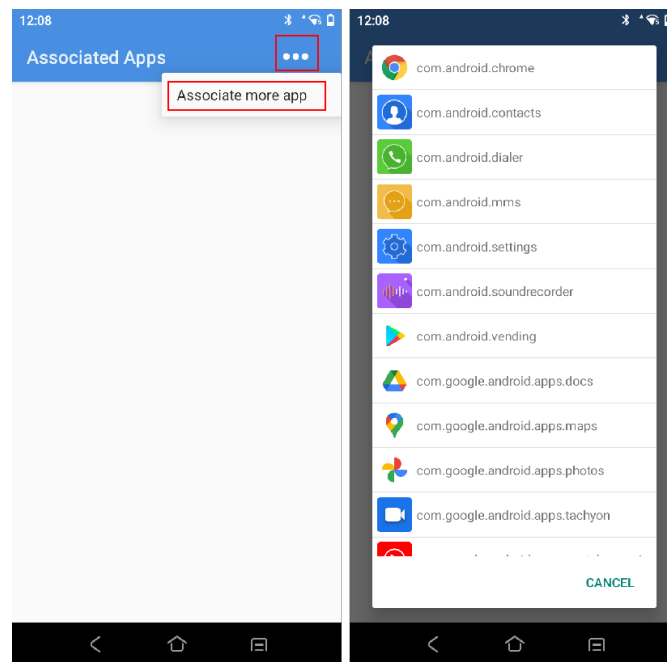

Figure 2-31 New Scan Settings

## 2.13 Feature Settings

The following setting switches are available in the system feature settings:

- **Status bar pull down:** the default is "on", if disabled, the status bar function cannot be modified.
- **Virtual key:** the default is "on", click on the virtual key at the bottom of the screen does not take effect after disabling the corresponding virtual switch.
- **Hide navigation bar:** the default is "off", select "on" if you want to hide the navigation bar at the bottom of the screen.
- **Input method Editor pops up automatically:** the default is "on", select "Disable this function" if you want to disable automatic pop-up of input method during code scanning.
- **Pop-up input method:** the default is "on", the soft keyboard cannot be popped up after closing.

- 
- **Show scan suspension button:** the default is "on", if you do not want to scan the key value of the button to be output in the application, select "Off".
  - **Automatic call recording:** the default is "off", all call recordings of the device will be automatically saved to local after turning on, which is convenient for information traceability.
  - **Three-finger screenshots:** the default is "off", take a screenshot by swiping up or down on the screen with three fingers simultaneously after turning on.
  - **Screen pinning:** the default is "off", the shortcut key ("power" key and "volume +" key pressed simultaneously) can fix the current screen after turning on, and at this time, you can only view the screen content, not to operate; if you want to cancel the fixed, press the shortcut key again.
  - **Default Launcher:** modifies the default desktop of the system, which will automatically enter the selected desktop.

## 2.14 Remap Key

Remap Key can keymap all physical keys except the power key, and the mapped keys will be given a new key value, that is, pressing the button can achieve customized functions.

1. Open "**Settings-Enterprise featured setting-Remap Key**" and check **Enable intercept key**;

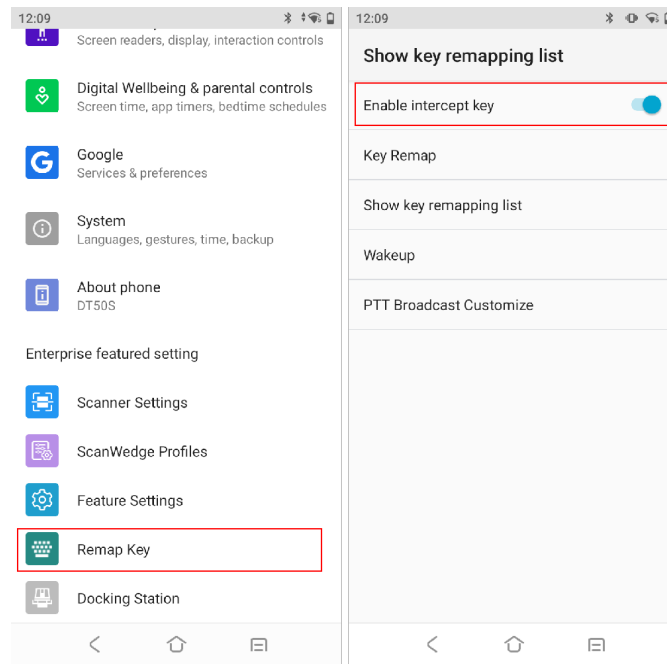

Figure 2-32 Remap Key

2. Touch **“Key Remap”** ;

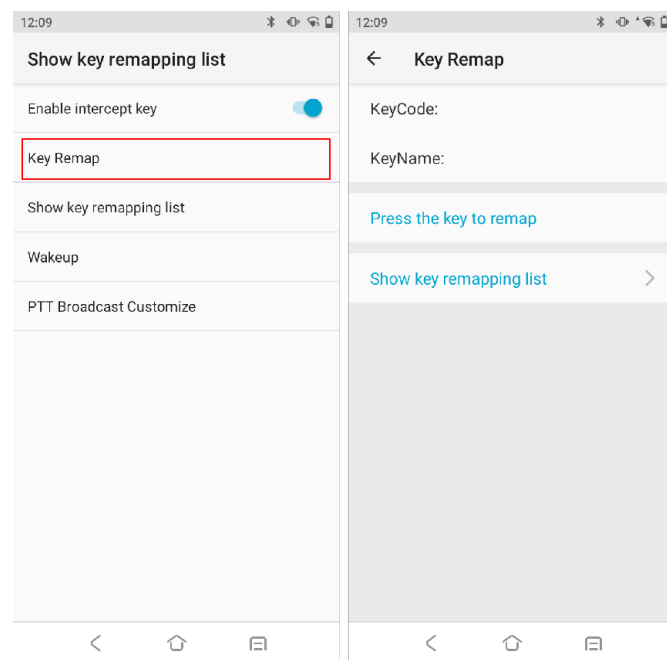

Figure 2-33 Key Remap Page

3. Press the physical key for key remapping, the key value and name will be shown;

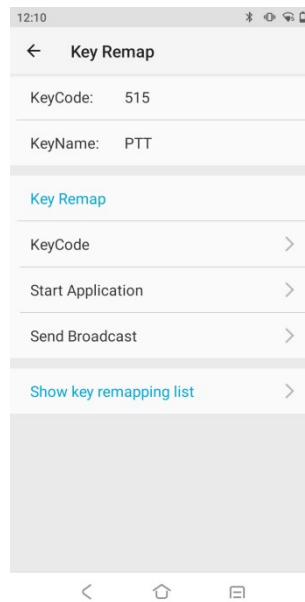

Figure 2-34 Key Remap Page

4. Tap **KeyCode**, **Start Application**, **Send Broadcast**, after finish setting, tap **Remap key**;

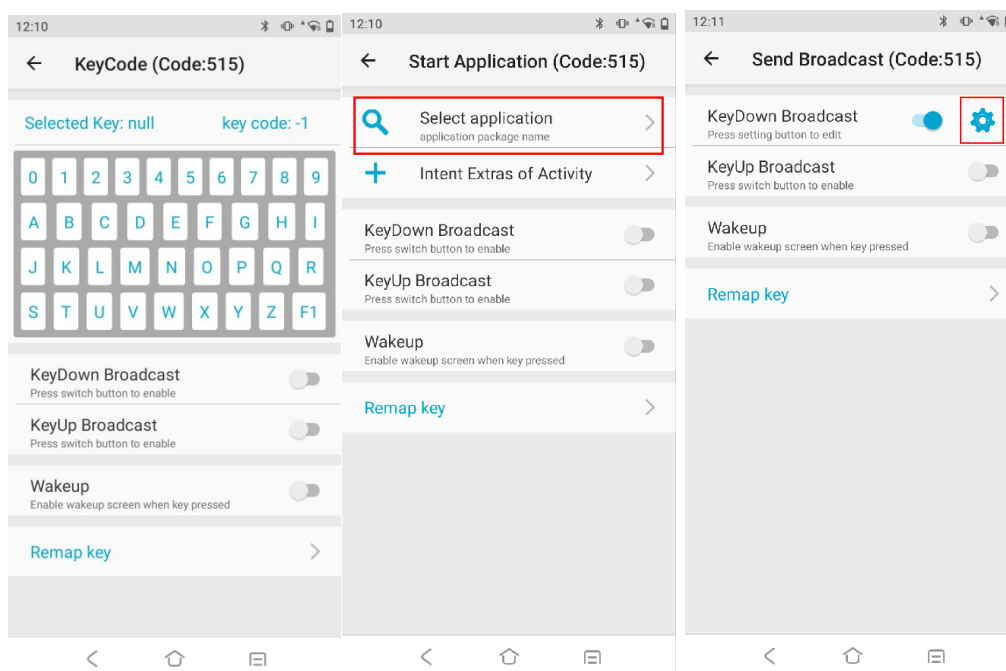

Figure 2-35 Key Remap options

5. View the remapped key list in the **Show key remapping list** to manage remapped keys;

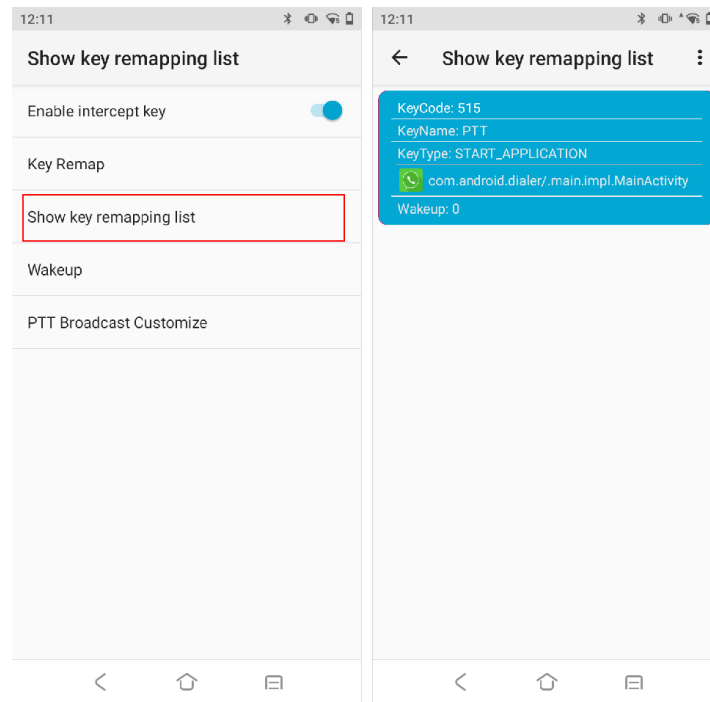

Figure 2-36 Show key remapping list

- a) Slide a certain option in the list to the left to reset the key to the default settings and clear the key's mapping value;

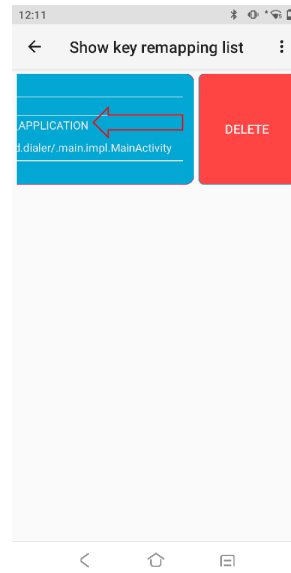



Figure 2-37 Key Remapping Deleting

- b) Touch the menu key or settings icon at the top right corner  to reset the value of each remapped key and restore the default value of each physical key.

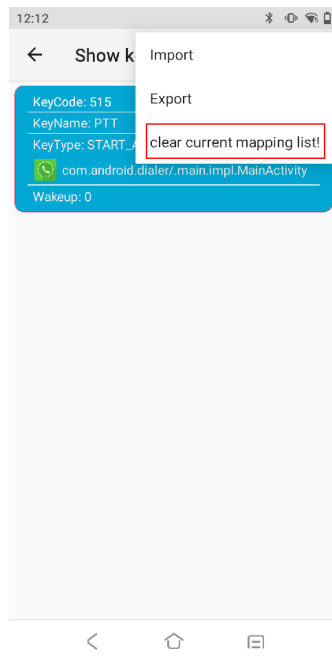

Figure 2-38 Remapped Key Resetting

# Chapter 3 Application

## 3.1 Access the application

Installed apps will be shown in the app center interface, except for ones in the background.

1. In the home screen, pull up the screen to enter the app center interface;

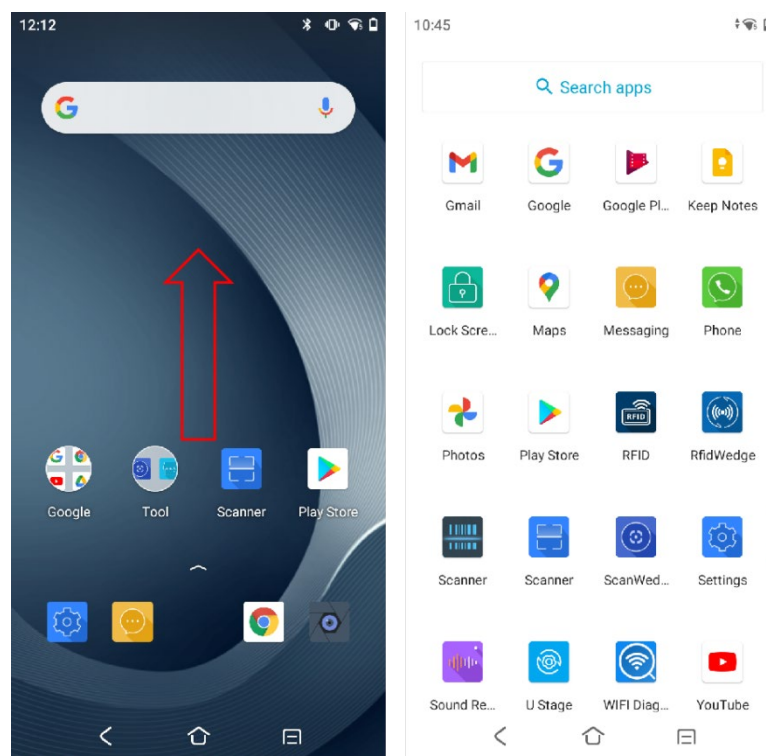

Figure 3-1 Enter App Center from main interface













2. Slide up or down to view more app icons and touch any app icon to be accessed to open the app.













## 3.2 App Profile









System apps are set forth in the following table.

*For detailed operation of the software, please contact the technical staff of UROVO for guidance.*

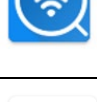

| Icon                                                                                | Description                                                                                                                                                |
|-------------------------------------------------------------------------------------|------------------------------------------------------------------------------------------------------------------------------------------------------------|
|    | <b>Maps</b> -Browse maps, search for locations, check bus and car routes, and view real-time traffic status                                                |
|    | <b>Phone</b> -dial a phone number for voice communications                                                                                                 |
|    | <b>Messaging</b> -receive and send SMS and MMS                                                                                                             |
|    | <b>Calculator</b> -provide basic and scientific calculating functions                                                                                      |
|    | <b>Sound Recorder</b> -record audio files                                                                                                                  |
|  | <b>Enterprise Launcher</b> -Restricts access to programs and settings on the device, enabling control of the device and simplifying the enterprise desktop |
|  | <b>Calendar</b> -view and manage calendar events.                                                                                                          |
|  | <b>Scanner</b> -test the engine module of scanner, Images can be displayed in real time                                                                    |
|  | <b>Scanner</b> -test the engine module of scanner                                                                                                          |
|  | <b>Settings</b> -configure DT50P.                                                                                                                          |
|  | <b>Clock</b> -set the alarm and timer                                                                                                                      |
|  | <b>Contacts</b> -manage contact information.                                                                                                               |

|                                                                                     |                                                                                                                                                                                                                             |
|-------------------------------------------------------------------------------------|-----------------------------------------------------------------------------------------------------------------------------------------------------------------------------------------------------------------------------|
|    | <p><b>U Stage</b>-Allows for fast configuration synchronization of devices. After the first device is configured according to enterprise requirements, the other devices can be configured in a simple and fast manner.</p> |
|    | <p><b>Files</b>-list all the files downloaded from the device</p>                                                                                                                                                           |
|    | <p><b>Photos</b>-view or edit photos in the device and microSD Card.</p>                                                                                                                                                    |
|    | <p><b>Camera</b>-take photos and record videos.</p>                                                                                                                                                                         |
|    | <p><b>Boost</b>-One click to clean up memory and free up storage space</p>                                                                                                                                                  |
|  | <p><b>Lock Screen</b>-Enables to lock the screen and put the device to sleep with one click</p>                                                                                                                             |
|  | <p><b>App Market</b>-download apps defined in the cloud management platform</p>                                                                                                                                             |
|  | <p><b>Drive</b>-Allows offline access to users' files stored and share them with others</p>                                                                                                                                 |
|  | <p><b>Chrome</b>-access the network</p>                                                                                                                                                                                     |
|  | <p><b>DUO</b>-For video calls</p>                                                                                                                                                                                           |
|  | <p><b>Gmail</b>- receive and send e-mails</p>                                                                                                                                                                               |
|  | <p><b>Google</b>-access the network</p>                                                                                                                                                                                     |

|                                                                                     |                                                                                                                                             |
|-------------------------------------------------------------------------------------|---------------------------------------------------------------------------------------------------------------------------------------------|
|    | <b>Google Play</b> -Allows users to browse, download and use applications published by Google                                               |
|    | <b>Keep Notes</b> -for easy creation of articles, pictures, voice notes, and timely uploading to the cloud for saving                       |
|    | <b>Play Store</b> -Used to find the latest Android apps, games, movies and more                                                             |
|    | <b>RFID</b> - Used to scan and identify RFID tags                                                                                           |
|    | <b>RfidWedge</b> - Allows to modify the default settings for RFID catching and to create new scan settings to be applied to custom software |
|    | <b>ScanWedge</b> - Allows to modify the default settings for scanning and to create new scan settings to be applied to custom software      |
|  | <b>WiFi Diagnosis</b> -Real-time analysis and troubleshooting of WiFi to pinpoint problems                                                  |
|  | <b>YouTube</b> -Used to download, watch and share videos or clips                                                                           |
|  | <b>YT Music</b> -Used to play audio files from this unit or stored in microSD                                                               |

### 3.3 Enterprise Launcher

Enterprise launcher software can maximize the needs of enterprise-side customers for PDA tools, bring a concise enterprise desktop to the market and customers, restricts access to programs and settings on the device without writing code. Through simple operation, realize the control of the equipment, and provide customers with convenient services.

The enterprise launcher can easily restrict the device to be used by one or more specified applications. It is like a local MDM (Mobile Device Management) and MAM (Mobile Application Management) with reduced functions and has partial Android permissions.

## User Interface

The user interface is the launcher used by the end user of the device, and will display applications that are only available to the user. The application of the user interface is fixed, there is no trigger effect after long press, and can not be uninstalled.

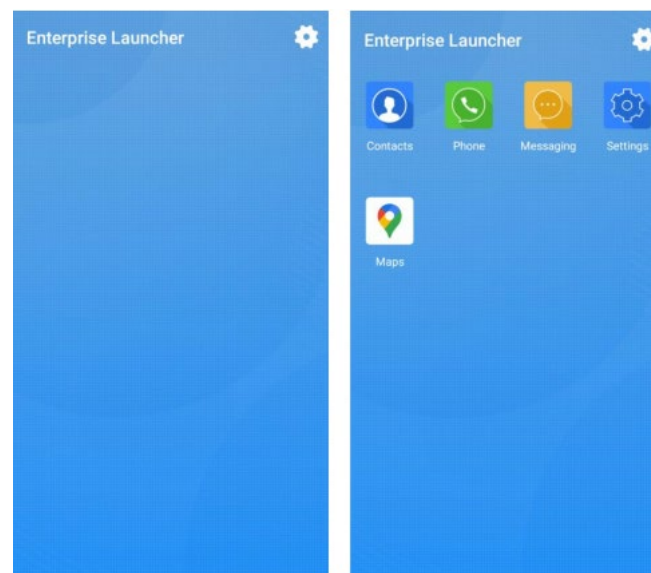

Figure 3-2 user interface

User can click the menu button in the upper right corner to enter the administrator settings interface or view device information. Click the "Launch" button to officially enable the enterprise launcher, and users cannot log out.

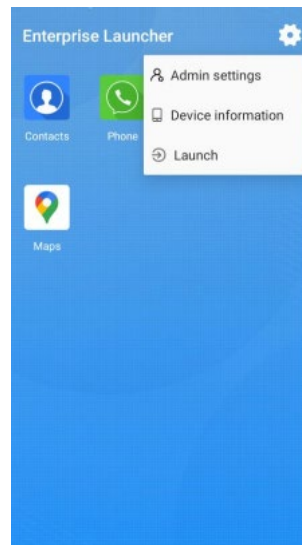

Figure 3-3 menu

## Administrator login

Click the menu key in the upper right corner of the user interface to enter the administrator login interface. To enter the administrator interface, you need to confirm the opening of the enterprise launcher, the login password is blank by default when you log in for the first time, and you can modify the password in the administrator settings interface after logging in.

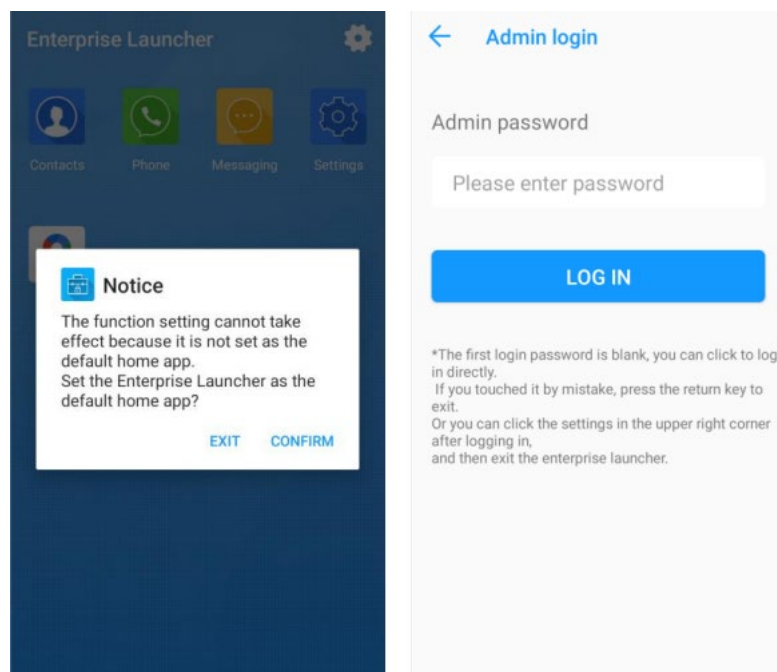

Figure 3-4 Administration login

## Administration interface

The administrator interface displays all the apps on the device, and you can install, uninstall, and view app details.

(1) Long press the application to pop up the selection bar: application details, uninstall.

(2) Click the menu button in the upper right corner of the interface to select: administrator settings, device information, and exit enterprise mode. Administrator settings: enter the administrator settings interface to set the enterprise desktop;

Device information: view device information;

Exit enterprise mode: exit the enterprise desktop and return to the Android launcher;

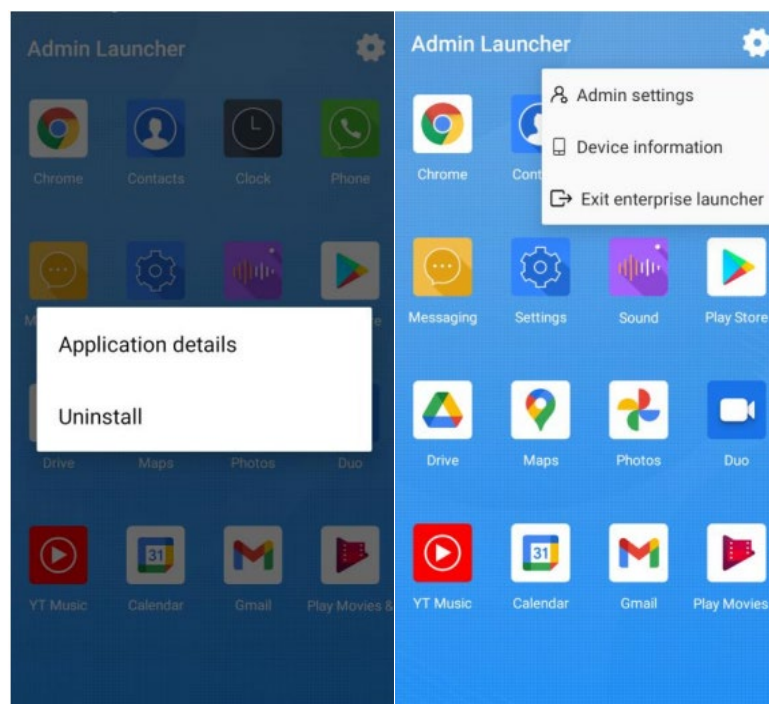

Figure 3-5 Administrator interface

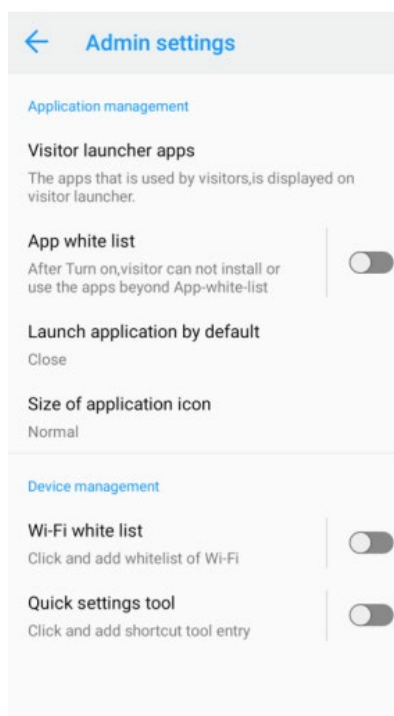

Figure 3-6 Administrator setting interface

## 3.4 U Stage

U Stage provides enterprise IT administrators and agents with quick device configuration synchronization. After the first device is configured according to enterprise requirements, other devices can be configured synchronously in a simple way, thus making mass devices reach their working state simply and quickly, facilitating enterprise control, and reducing the errors of human configuration.

### Configure

Before using this program, the current prototype must be configured to the working state.

The range of configuration includes system settings and scanner settings, such as WIFI switch, network automatically saved under WIFI, and time zone setting in system settings, as well as scanner configuration, such as scanning handle switch, broadcast configuration, and barcode setting. After setting items are configured, you can enter the U Stage program.

## Export

After the standard configuration of the prototype is completed, export the configuration scheme. U Stage provides 3 transmission modes.

### 1) Upload to UMS

If the device has been bound to the UMS, click to automatically upload the current configuration to the UMS - Configure Management page. You can import the configuration in batches silently on the UMS background.

### 2) Generate barcode

Import the configuration to the barcode for other devices to scan and import.

### 3) Export to local

Export the configuration to local to generate 2 files, such as scanner\_system\_5.pdf. This file contains barcode for configuration. The IT administrator can transfer the file to the customer or print the file for the user to scan and import.

And scanner\_system\_5.txt. This file can be uploaded to the MDM platform for remote silent deployment.

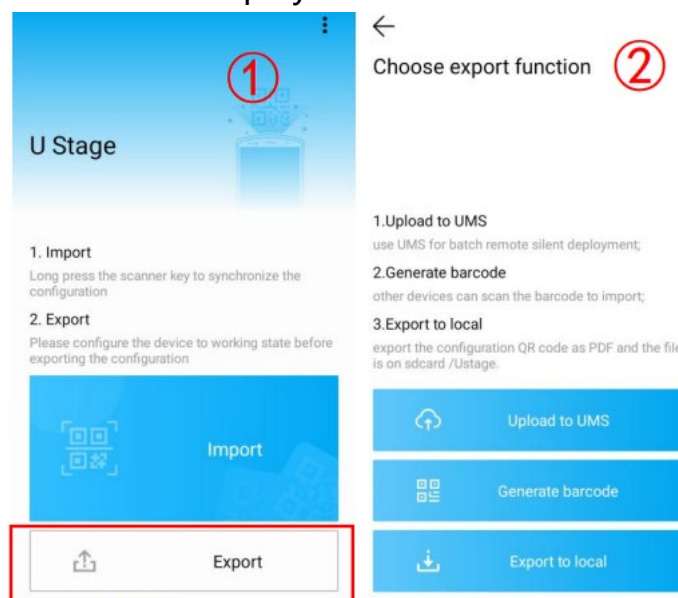

Figure 3-7 Choose export function

## Import



After clicking "Import", the scanner will light up (or use the physical scanner key); then scan the QR code generated in the previous step, and reboot after the devices execute the configuration to complete deployment.

### 3.5 WIFI Diagnosis

Real-time WiFi analysis and troubleshooting tools can accurately locate the problem and solve the problem immediately. This tool provides reliable and excellent WiFi experience, improves customer business efficiency and collaboration, and simplify the process of customers configuring complex WIFI for special environments.

#### Main interface

View the current signal details, including the currently connected WIFI name, signal strength (dBm), frequency band, channel, IP and MAC address, etc. The interface displays the waveform graph of signal intensity changes in an intuitive and real-time manner. The interface also shows the entrance to the function module.

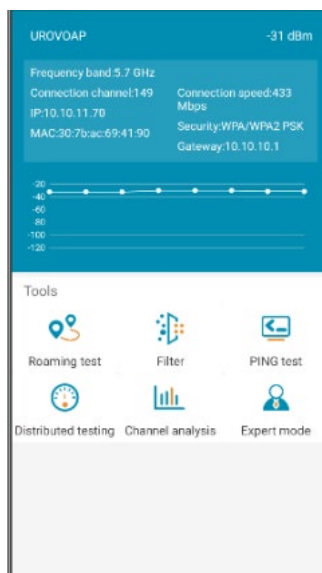

Figure 3-8 WIFI diagnosis main interface

- **Roaming test:** The roaming test is to test the packet loss during roaming process and observe the roaming handover between APs.

- 
- **Filter:** Filter function, according to the manually selected conditions, to filter out only the WiFi that meets the conditions, so that you can find the WiFi you need.
  - **PING test:** Test the connectivity of the current connected network, the packet loss rate and stability.
  - **Distributed testing:** Check the WIFI situation around the device, including information such as channel, MAC address, etc., to help customers understand the surrounding wireless distribution.
  - **Channel analysis:** Channel analysis, can intuitively see the interference of each channel, select different WLAN frequency bands, and view the channel signal conditions of the corresponding frequency bands to understand The WiFi frequency band distribution around the current settings and the interference of each channel.
  - **Expert mode:** set the threshold of WIFI roaming, control whether to turn on roaming, set WLAN and designed channel connection, in order to intervene and improve the WIFI connection.

## 3.6 Description of Computer Connected Operation

If Android system driver or Android mobile assistant is installed in your personal computer, you may connect the device to the PC via the device' s USB cable.

### 3.6.1 Developer options

1. If it is a first-time debugging, open "**Setting-About phone**" , then click the version number continuously, bring up developer mode;

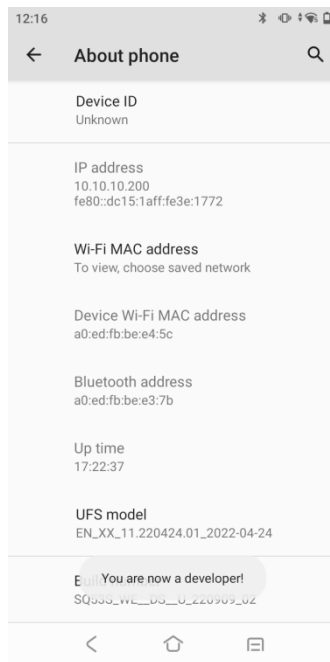

Figure 3-9 developer mode

3. Open "**Settings-System-Advanced-Developer options**" , Enable USB Debugging to enter the debugging mode;

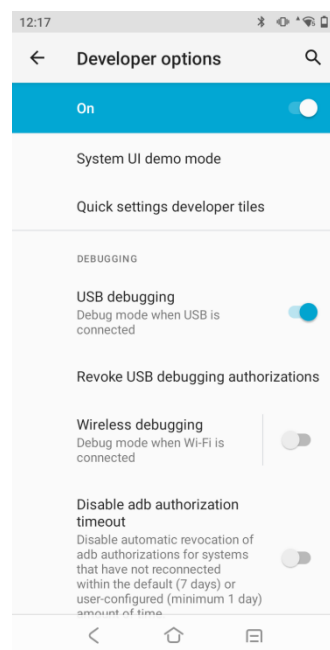

Figure 3-10 USB debugging

4. Insert one end of the device' s USB cable to the device and the other to the PC' s USB port to connect the device to the PC, then a USB enabling popup will be shown. Tick " Allow this computer for

debugging” and select” OK” and this popup will not seen when the device is connected to the PC next time.

### 3.6.2 File management by media transfer protocol (MTP)

1. Connect the device to PC by a USB cable;
2. Pull down the status bar to open the notification panel. Select "File Transfer" in USB Purpose to transfer media files to Windows or transfer files by any Android file transfer app to Mac (please refer to [www.android.com/filetransfer](http://www.android.com/filetransfer)).

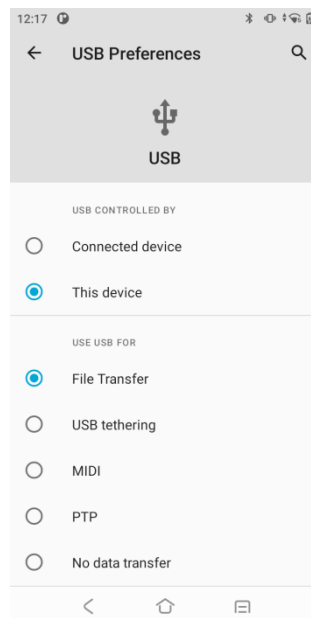

Figure 3-11 File Transfer

3. At PC end, open My Computer to access DT50P device;
4. Open an internal storage folder or SD card folder;
5. Manager media files needed.

### 3.6.3 Picture management by picture transfer protocol (PTP)

1. Connect the device to PC by a USB cable;

2. Pull down the status bar to open the notification panel and select **PTP** in **USB Preference** to transfer photos to Windows;

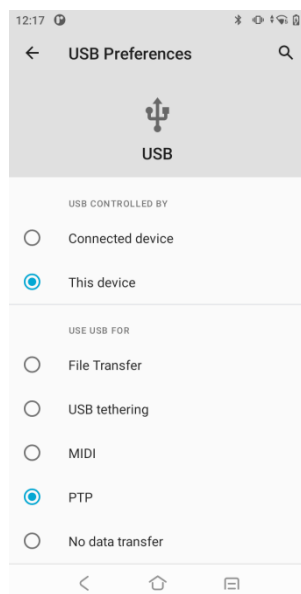

Figure 3-12 PTP

3. At PC end, open My Computer to access DT50P device;
4. Open an SD card folder or internal storage folder;
5. Manage picture files needed.



Figure 3-13 PTP Folder Shown at PC

### 3.6.4 Charging mode

1. Connect the device to PC by a USB cable;
2. Pull down the status bar to open the notification panel and select **No data transfer** in **USB Preference** to transfer photos to Windows;

3. In the charging mode, data communication is not available.

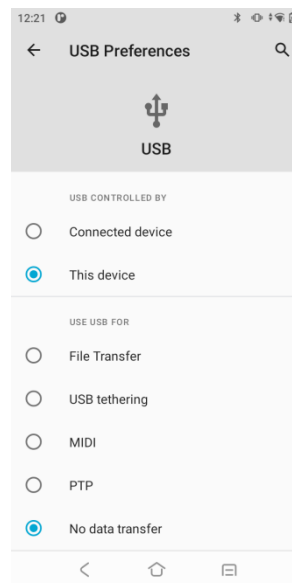

Figure 3-14 Charging mode

### 3.6.5 Disconnection from PC

**Caution: Please safely unplug the device as instructed at PC before removing the USB cable in case of loss of data.**

1. Find the external device identification in the task bar at the bottom right corner of PC;
2. Right click to select Unplug DT50P Device;
3. Carefully remove the USB cable.

# Charter 4 Accessories

## 4.1 List of Standard Accessories



Figure 4-1 Power adapter



Figure 4-2 Type-C USB cable



Figure 4-3 DT50P battery 9000mAh

## 4.2 List of Optional Accessories

### Single Charging Cradle:

- support charging one device and one battery;
- support LED charging status indicator ;
- charging cradle adapter output: 12V/2A.



Figure 4-4 Single Charging Cradle

### Screen Protector:

- Improve protection performance



Figure 4-5 Screen Protector

### Holster:

- Lightweight and convenient , easy to carry around;
- Nylon material, wear-resistant and durable



Figure 4-6 Holster



---

# Chapter 5 Maintenance and Troubleshooting

## Introduction

This chapter sets forth the device's maintenance methods and troubleshooting solutions to help users use the product appropriately.

## 5.1 Maintenance

To ensure that the device does not break down, please abide by the following instructions while using DT50P:

- Do not scratch the screen of DT50P. While using DT50P, please use a recognized touch pen or any other pen which is fit for touching with point made from plastics. Please do not use a real pen, pencil or anything sharp to touch the screen of DT50P.
- The screen of DT50P is made from glass. So please do not make DT50P fall on the ground or get hit.
- Prevent DT50P from bearing too high or low temperature. Do not put the device on any automotive instrument panel in hot weather. Keep it away from any heat source.
- Do not use DT50P anywhere dusty, damp or moist.
- Clean the scanning engine and camera of DT50P by soft lens cloth. If the screen of DT50P gets dirty, please clean the screen by soft cloth with diluted glass cleaning solution.

## 5.2 Cleaning

### Housing

Scrub the housing by cloth with alcohol, including keys.

### Display screen

Scrub the display screen by alcohol wipes but be sure that no liquid drops nearby the edge of the display. Immediately dry the display screen by soft and abrasive-free cloth to prevent mark left.

### Camera and scanning window

Please scrub the camera and scanning window by lens wipers or other materials made for cleaning optical materials (e.g., glasses).

## 5.3 Troubleshooting

| Problem                                                                                       | Reason                                             | Solution                         |
|-----------------------------------------------------------------------------------------------|----------------------------------------------------|----------------------------------|
| Press the power key but DT50P does not work                                                   | The battery is not charged                         | Charge the battery               |
|                                                                                               | The system crashes                                 | Execute resetting                |
| The battery is not charged                                                                    | The battery breaks down                            | Replace the battery              |
|                                                                                               | The battery's temperature is exceptional           | Contact for technical support    |
| During data communication via Wi-Fi, no data are transferred or not all data are transferred. | Wi-Fi communication is not enabled                 | Enable Wi-Fi communication       |
|                                                                                               | The device is out of the range of the access point | Move closer to the access point  |
| During data communication via                                                                 | Bluetooth communication is not enabled             | Turn on Bluetooth communication. |

|                                                                                       |                                                                          |                                                                                                                                                               |
|---------------------------------------------------------------------------------------|--------------------------------------------------------------------------|---------------------------------------------------------------------------------------------------------------------------------------------------------------|
| <p>Bluetooth, no data are transferred or not all data are transferred</p>             | <p>The device is out of the signal range of another Bluetooth device</p> | <p>Move within 10m (32.8ft) range of another device.</p>                                                                                                      |
| <p>No sound</p>                                                                       | <p>Volume setting is too low or turned off</p>                           | <p>Adjust volume</p>                                                                                                                                          |
| <p>DT50P is off</p>                                                                   | <p>DT50P is at inactive state</p>                                        | <p>Not use for a while, the display will automatically turn off. Set the duration to be longer, such as 15 s, 30 s, 1 min, 2 min, 5 min, 10 min or 30 min</p> |
|                                                                                       | <p>The battery is depleted</p>                                           | <p>Charge the battery</p>                                                                                                                                     |
| <p>Tapping a window button or icon but fail to trigger the corresponding function</p> | <p>The device does not respond</p>                                       | <p>Reset the device</p>                                                                                                                                       |
| <p>A message pops up, indicating that DT50P's storage is full</p>                     | <p>Too many files are saved in DT50P</p>                                 | <p>Delete unused memos and records. If necessary, save such records in the host (or use SD Card as additional</p>                                             |

|                                                |                                                                      |                                                            |
|------------------------------------------------|----------------------------------------------------------------------|------------------------------------------------------------|
|                                                |                                                                      | memory)                                                    |
|                                                | Too many apps are installed in DT50P                                 | Uninstall unused apps in DT50P to recover storage capacity |
| DT50P fails to decode while reading a bar code | The bar code is unreadable                                           | Check the barcode is not damaged                           |
|                                                | The distance between the laser scanning window and bar code is wrong | Put DT50P within proper scanning range                     |
|                                                | The bar code type is not checked, or bar code length is wrong        | Set DT50P to accept the scanned bar code type              |
|                                                | Battery low                                                          | Check the battery level                                    |

### **Precautions:**

1. To avoid unnecessary injuries, please read this instruction manual before using the equipment to ensure proper and safe use.
2. Please use the accessories approved by the manufacturer and matched with this model of equipment. If you use a power supply,

---

charger or battery that is not approved by the manufacturer, it may cause fire, explosion or other hazards.

3. Please use this equipment under the specified temperature of the equipment, as too high or too low ambient temperature may cause equipment failure.

4. Do not disassemble the equipment or its accessories without permission. If the equipment or any of its parts do not work properly, please consult our after-sales service staff or send the equipment to the after-sales service network for inspection and repair.

5. There are two types of laser warning signs posted near the scanning engine, please do not intentionally aim the laser at the eyes, because a long time direct exposure of the eyes by the laser may cause irreversible damage.

6. In the case of battery bulge, smoke, leakage and other suspected battery failure, please contact the manufacturer in a timely manner for after-sales treatment.

Attachment :

# **RFID-Demo User Manual**

## **Version V22**

**UROVO TECHNOLOGY CO., LTD.**  
**June 1, 2023**

---

## Statement

This document is owned and interpreted by UROVO TECHNOLOGY CO., LTD. and shall not be copied, disclosed or sold to third parties without the written permission of UROVO TECHNOLOGY CO., LTD.

This document is the functional operation instructions of RFID-Demo. The specific operation is subject to the functions of the user's handheld device. Read the instruction manual in detail before use, and make operation in accordance with standards.

| Version | Date               | AMD | Revised by   | Description                                                                                                                                                                                                                                                                                                                                                                                                                                                                                                                                                   |
|---------|--------------------|-----|--------------|---------------------------------------------------------------------------------------------------------------------------------------------------------------------------------------------------------------------------------------------------------------------------------------------------------------------------------------------------------------------------------------------------------------------------------------------------------------------------------------------------------------------------------------------------------------|
| V1.0    | January 29, 2021   | A   | Gong Yi      |                                                                                                                                                                                                                                                                                                                                                                                                                                                                                                                                                               |
| V1.1    | April 13, 2021     | M   | Gong Yi      | <p>1.pop-up window that indicates unsuccessful RFID connection is added.</p> <p>2.Options of long- and short-distance module are added.</p>                                                                                                                                                                                                                                                                                                                                                                                                                   |
| V1.2    | September 15, 2021 | A   | Qiu Yangfang | 1.A handle indicator initialization button is added for products with a removable handle.                                                                                                                                                                                                                                                                                                                                                                                                                                                                     |
| V1.3    | June 15,2022       | M   | Qiu Yangfang | Read and write label modification, before can read multiple, after modification, can only read one by one.                                                                                                                                                                                                                                                                                                                                                                                                                                                    |
| V22     | June 1,2023        | M,D | Qiu Yangfang | <p>1.Remove the mode selection;</p> <p>2. Remove the settings interface (connecting serial port, antenna sensitivity, quick reading of TID tags, reader status reader identification, reader RS-485 address);</p> <p>3. Add the function of setting custom parameters in the settings interface;</p> <p>4.Two new query methods have been added to the scanning interface;</p> <p>5.Inventory data can be returned to TID;</p> <p>6.Modify the data selection methods for read/write, lock, and destroy interfaces;</p> <p>7.Added InventoryLed function;</p> |

(A-Add, M-Modify, D-Delete)



---

contents

contents ..... I

I. Scan..... II

II. Tag Management ..... III

    2.1 Read/Write ..... IV

    2.2 Lock..... V

    2.3 Kill ..... VI

III. Filter.....VII

IV. Location ..... VIII

V. Settings ..... IX

VI. InventoryLed ..... 1

# I. Scan

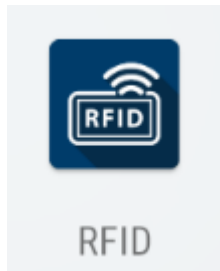

Visit the main page of the App by clicking the RFID icon, and you will be required to choose a UHF RFID module for your first visit. Choose the module appropriate to your product type as instructed and then click the START SCANNING button to start RFID label scanning with default settings.

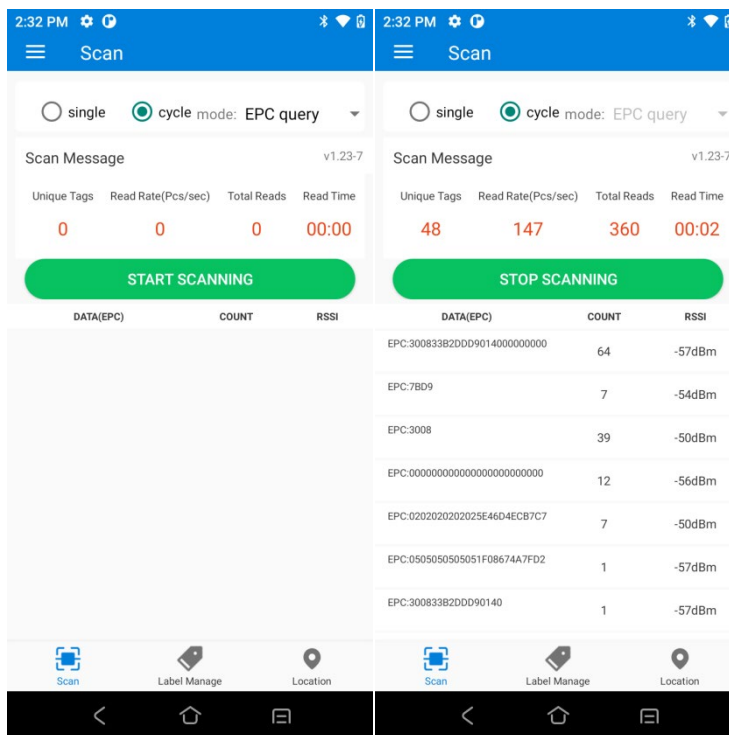

The meaning of the data displayed is as follows:

|                     |                                                                                                                                                                  |
|---------------------|------------------------------------------------------------------------------------------------------------------------------------------------------------------|
| V0.00-?             | Module firmware version number (?=7, 5, 3, R, C, M correspond to E710/E510/E310/R2000/C6/M100 respectively).                                                     |
| Unique Tags (Pcs)   | The count of unique tags that have been scanned in total since tapping the Start Scanning button.                                                                |
| Read Rate (Pcs/sec) | The rate of tag read.                                                                                                                                            |
| Total Reads         | One tag EPC is recorded as one piece of tag data. Here shows the counted total numbers of data in real time, including the data of the same tag read repeatedly. |

|           |                                                                  |
|-----------|------------------------------------------------------------------|
| Read Time | The total read duration since tapping the Start Scanning button. |
|-----------|------------------------------------------------------------------|

The fields in the tag list have the following meanings:

|          |                                                                                                                     |
|----------|---------------------------------------------------------------------------------------------------------------------|
| DATA(??) | The specific data scanned in the area (?? depending on the scan area selected, the corresponding area is displayed) |
| COUNT    | Number of times of tag being recognized                                                                             |
| RSSI     | Signal intensity at the last time of tag being recognized                                                           |

Note: A pop-up window as shown below will appear when you open the App if there is no RFID module or the RFID module is failed to be connected.

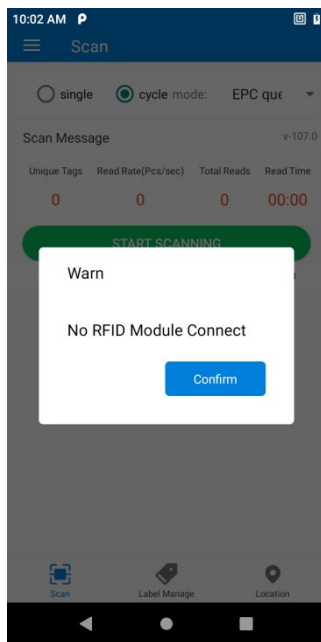

## II. Tag Management

The tag management page can be accessed through the Tag Management / Sidebar at the bottom of the home page. The main functions of the module are to read, write, lock and kill tags.

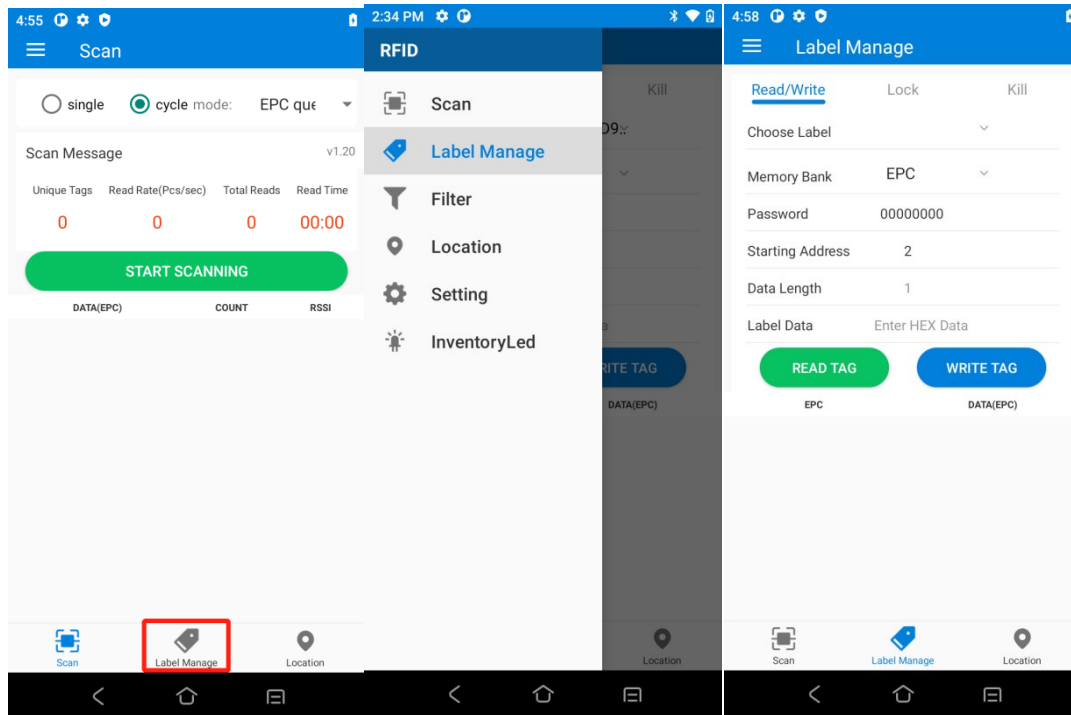

## 2.1 Read/Write

Before reading labels, scan and take inventory on the label scanning interface. After the inventory is complete, click Label Management and select the labels to be read and written to write labels or labels.

To read a tag, three parameters need to be entered: the tag area to be read, the starting address and the data length.

Note that the input parameters should be in accordance with the tag specifications. Otherwise, an error message will be prompted.

The interface for writing tag is in the same area as the reading, except that the writing requires the access password and the data to be written.

(The default access password is 00000000)

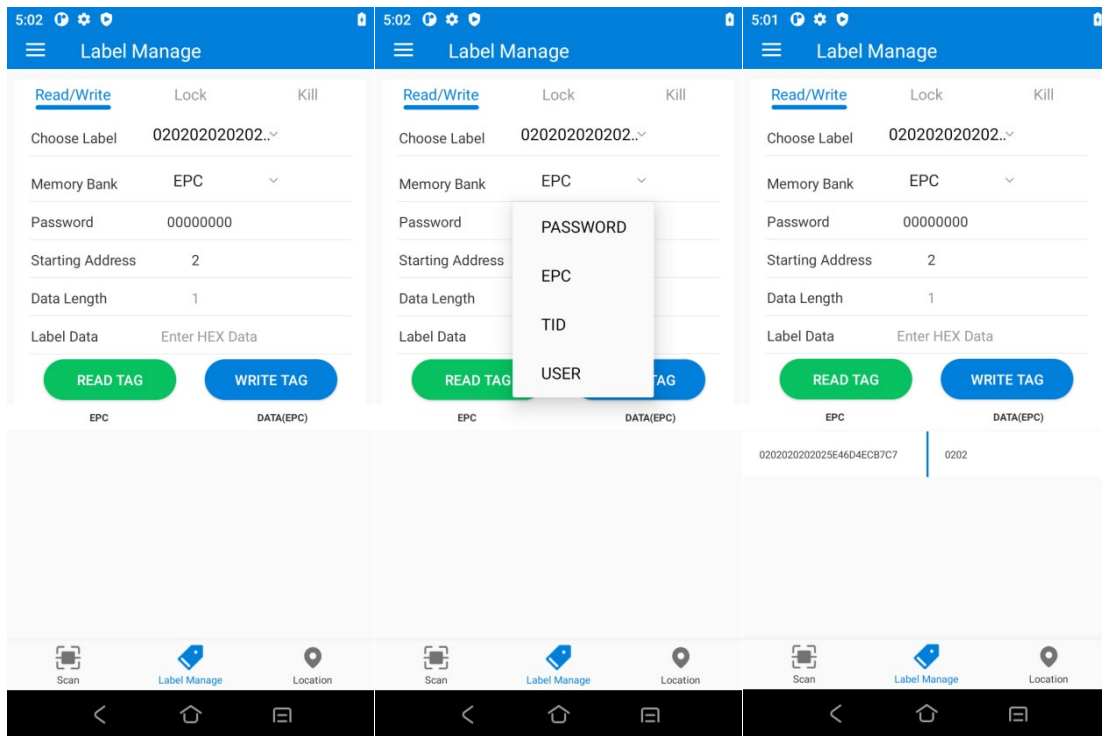

Note: The maximum writing length at one time is 32 words (64 bytes, 512bits).

## 2.2 Lock

The operation interface for locking tags is as follows:

An access password must be provided to lock the tag.

1. Select the storage area that needs to be locked;
2. Fill in the access password for the label;
3. Select the locking method;
4. Select the label that needs to be locked;

Note: The original password is not valid for locking. It is recommended that the user change the access password before locking the tag.

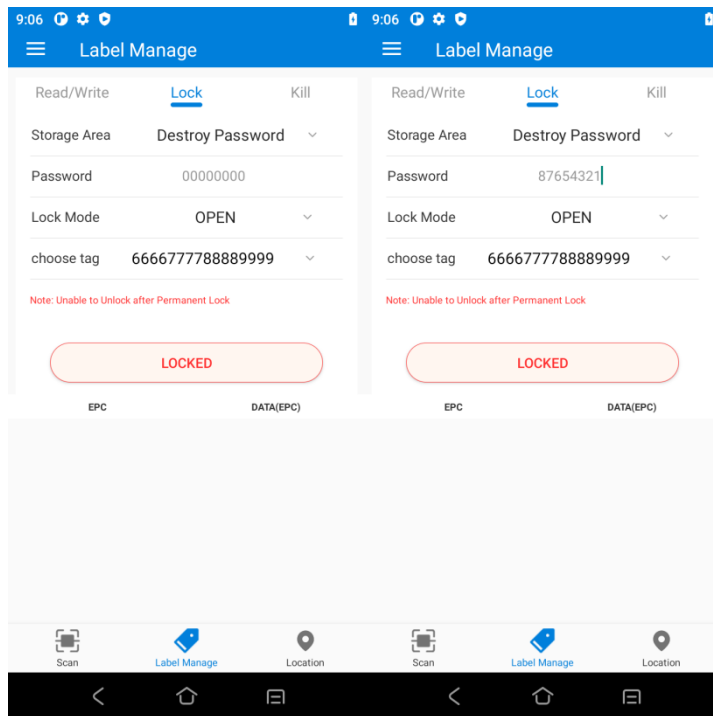

After successful operation, the following information will be returned.

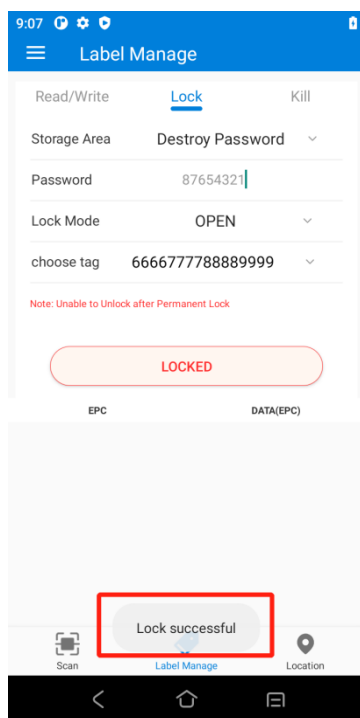

## 2.3 Kill

The operation interface for destroying tags is as follows:

To destroy a tag, the kill password must be provided, and the kill password cannot be 00 00 00 00. So to destroy a tag, you must first modify the content of the kill password in the password area by the command to write tag.

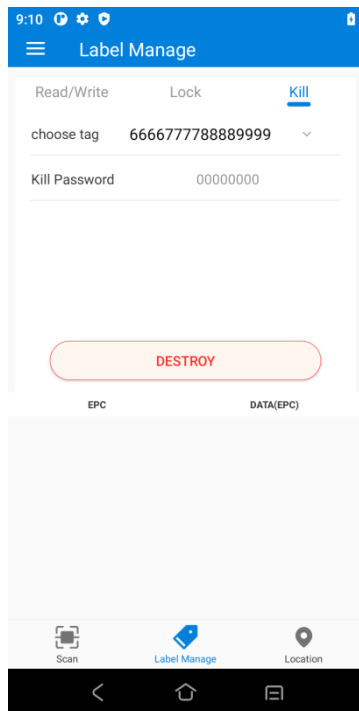

### III. Filter

Tap sidebar Filter to enter the filter settings page, and main functions of the module is to filter and weed out the content of the tag scanning.

Filtering settings include 4 types: Partial Filter, Fully Filter, Partial Weed out, Fully Weed out

1. Partial Filter: If the input data information and tag information are partially continuously overlapped, then filter out accordingly (for example: input 123, filter tag 123455, 645674123; retain: 14552443)
2. Fully Filter: If the data information and tag information are identical, filter out (for example: input 123456, filter: tag 123456, retain: 123456789, 33123456, 1233456)
3. Partial Weed out: If the data information and tag information are partially continuously overlapped, weed out and display these tags
4. Fully Weed out: If the data information and tag information are identical, weed out and display these tags

Note: The starting address can be set for Fully Filter and Fully Weed out

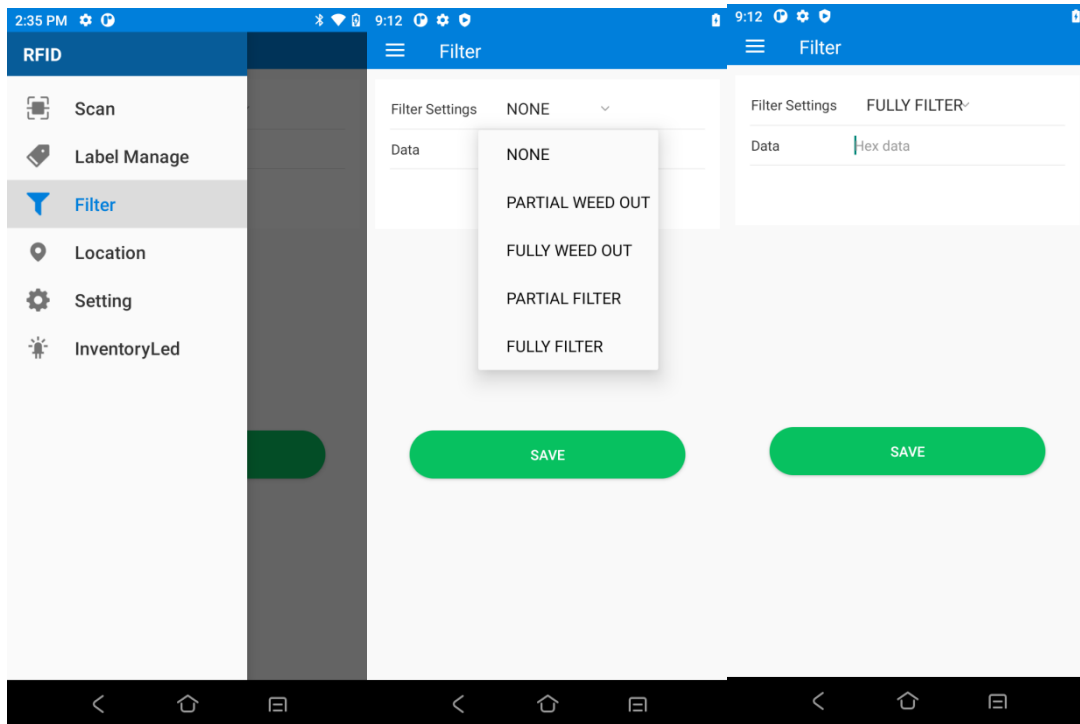

## IV. Location

The main purpose of this function is to display the relative positional relationship between the RFID Reader and the tag.

First scan the tags, then select a particular tag.

Switch to the Location page (the tag just selected will be displayed above) and click the start button.

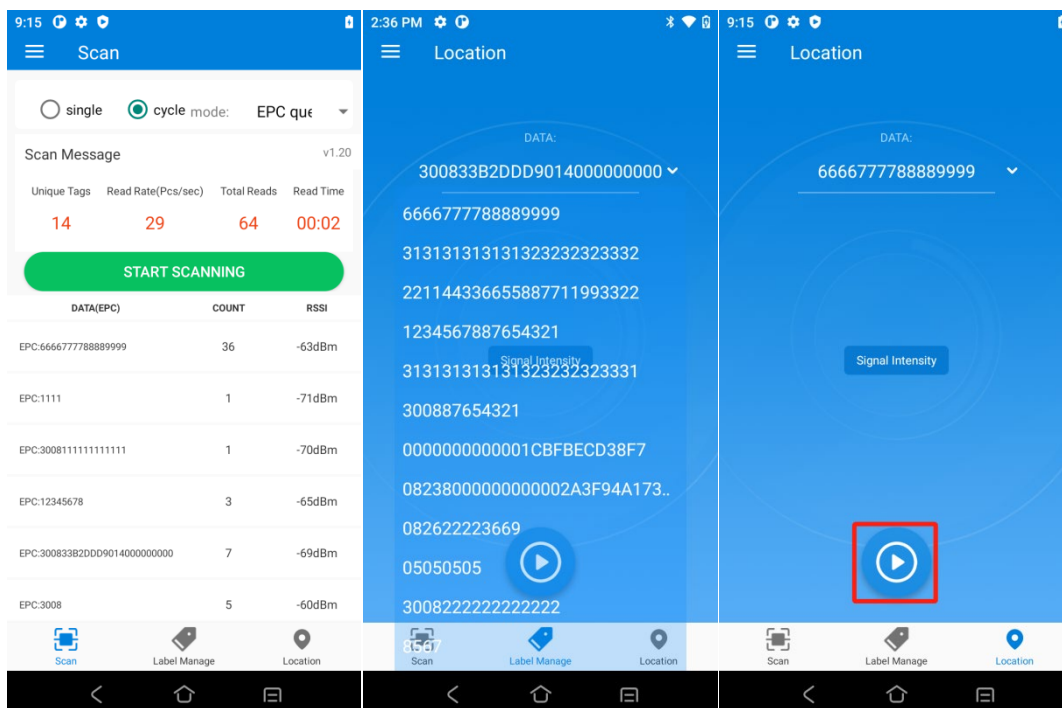



After starting, the page will display the Signal Intensity in real time. The larger value means the stronger signal and closer to the tag

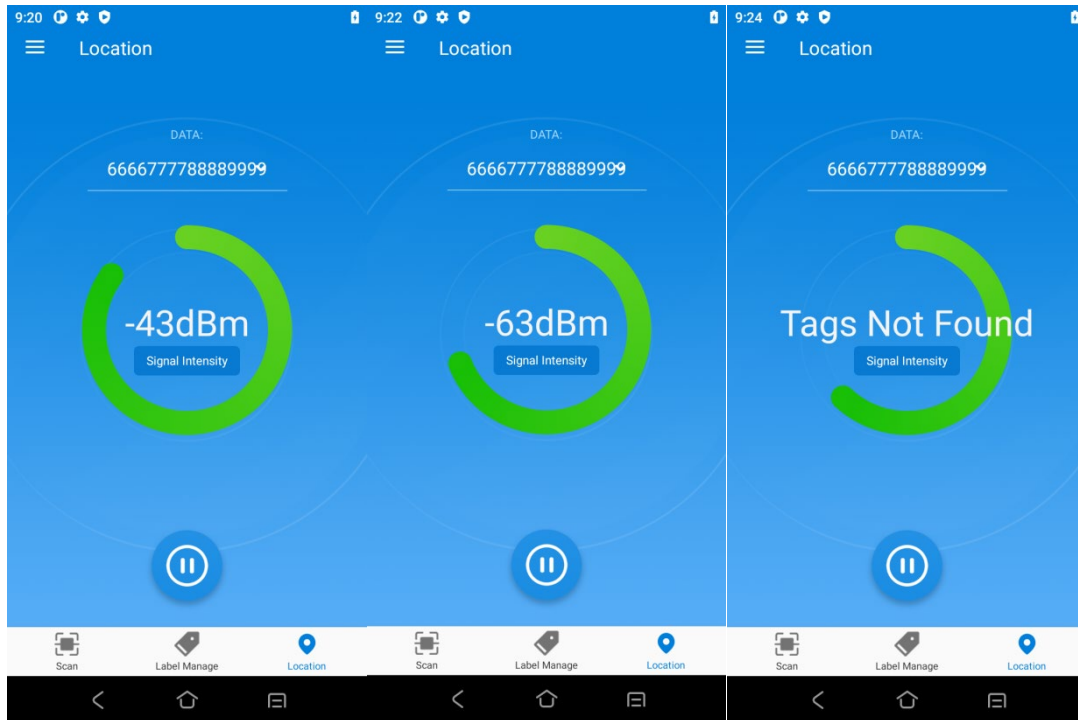

## V. Settings

Tap sidebar Setting to enter the setting page, mainly for the configuration of the RFID Reader.

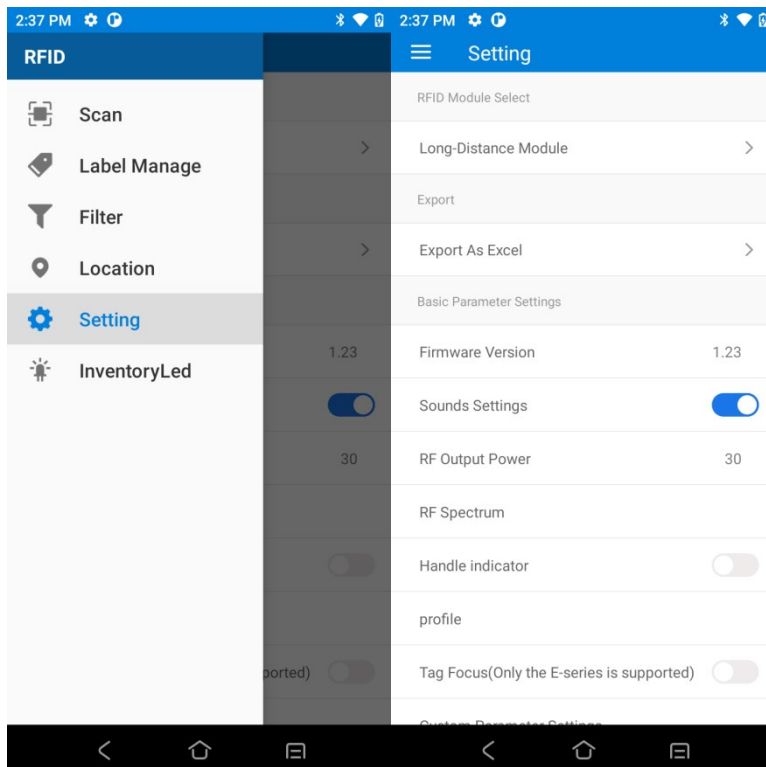

Options of UHF RFID Module: Automatically select corresponding modules based on device type.

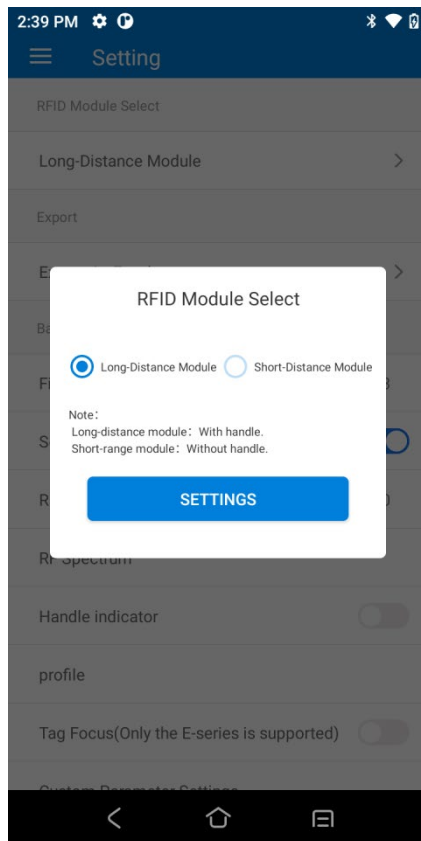

Connect Serial Number: It can be used by default and does not need to be modified

Export: The current tag scanning data can be exported to Excel

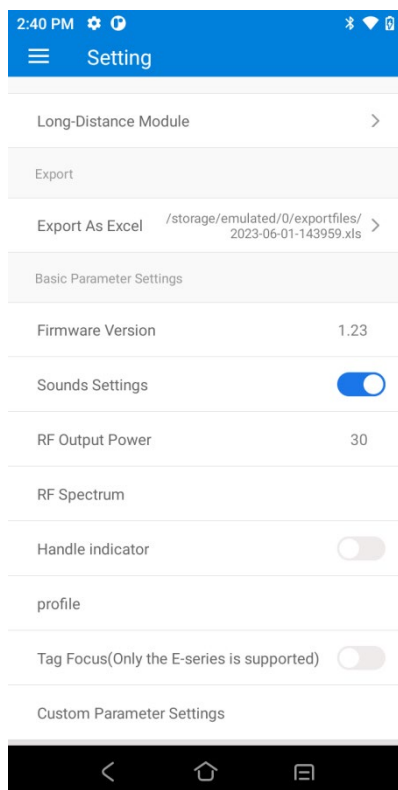
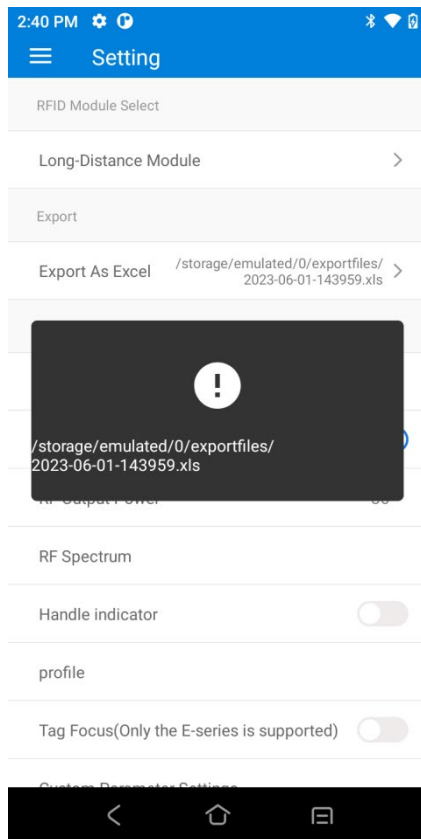

**Basic Parameter Settings:**

1. **Firmware Version:** Display the current firmware version
2. **Sounds Settings:** Set whether to beep during scanning, which is enabled by default

3. RF Output Power: The default is as follows, which can be read and set

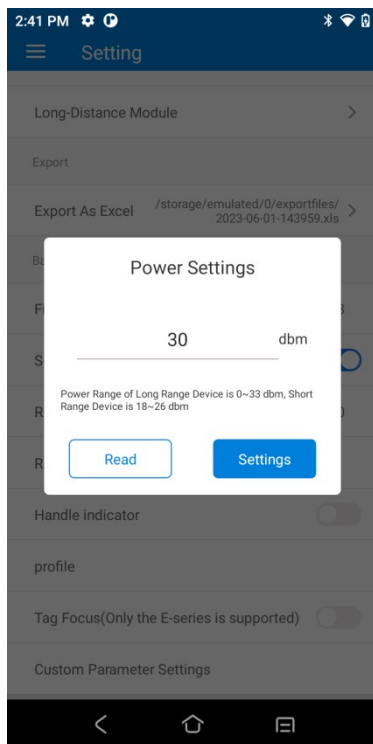

4. RF Spectrum: The default is as follows, which can be read and set

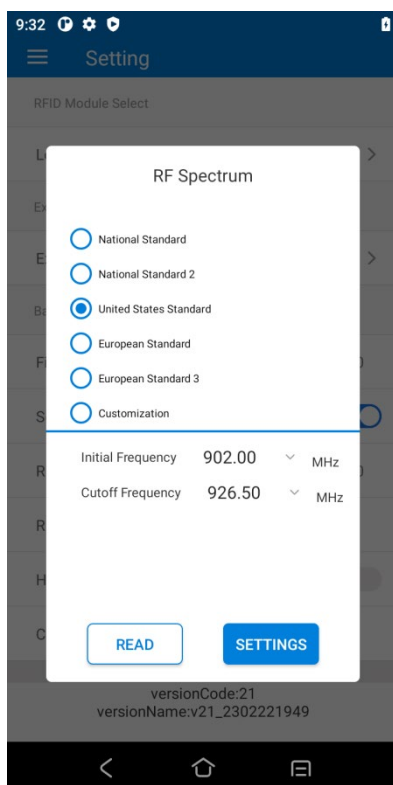

Note: When setting the frequency band, it is necessary to determine whether the antenna is a European standard antenna or an American standard antenna. Setting it incorrectly may result in the tag not being read.

5. Handle indicator: for products with a removable handle, the second indicator on the right side of the removable handle will flash when you scan if it is turned on. To turn it off, click it again.

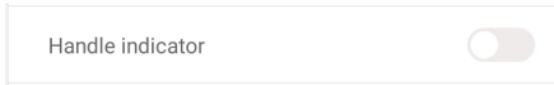

### 6. Profile

In the profiles supported by the E-series:

Mode 13: 160k, M8, 20us (farther distance when reading a single card)

Mode 15: 640k, M4, 7.5us (better group reading effect)

### 7. Tag Focus (only supports E-series)

This function only supports the use of E-series module devices;

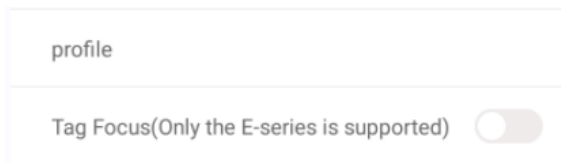

Read more tags in a shorter time, such as 400 tags. At the same reading time, if not opened, 200 tags may be read, but if opened, 400 tags can be read.

8. Custom parameter settings: Customize parameter configurations according to requirements.

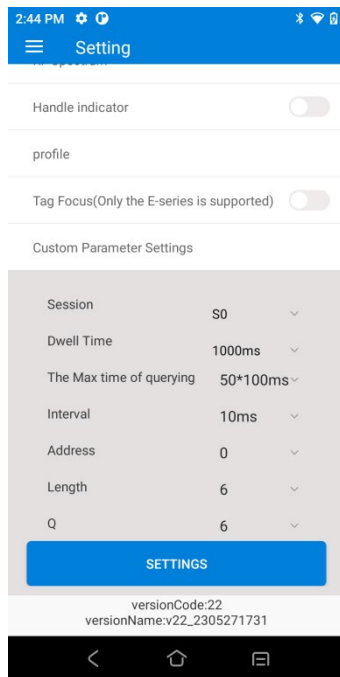

The following modes have been added to the Session

Auto1: S2/S3 alternating operation

Auto2: Extreme Inventory Mode

Auto3: Fast limit inventory mode

**Single card long-distance mode (E-series):**

Power: 33dBm, Profile: Mode 13, Tag Focus:OFF,Session: S0, dwell time: 1000ms, The Max time querying: 50 \* 100ms, interval: 0ms, Q: 4.

**Group reading optimization mode (E-series):**

Power: 33dBm, Profile: Mode 15, Tag Focus:ON,Session: AUTO3, dwell time: 1000ms, The Max time querying: 50 \* 100ms, interval: 0ms, Q: 6.

**Group reading range mode (E-series):**

Power: 33dBm, Profile: Mode 5, Tag Focus:ON,Session: AUTO1, dwell time: 200ms, The Max time querying: 50 \* 100ms, interval: 30ms, Q: 6.

## VI. InventoryLed

This feature supports the manufacturer labels of Kailuwei and Yilian. Select the label that needs to be inventoried, and the inventoried label will follow the flashing light of the disk.

To select the manufacturer who needs to read the label, first inventory the label, select and check the checkbox to the right of the label that needs to be read, and click Inventory;

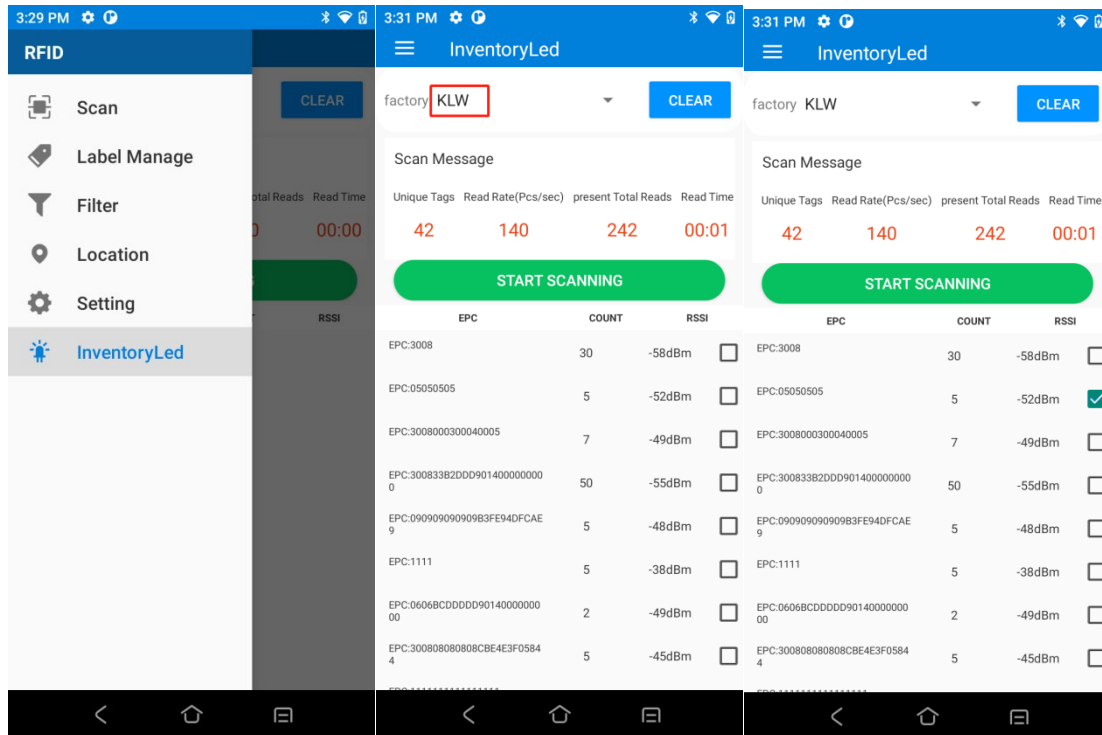

The inventory label indicator light will follow the disk reading and light up.

