

Applicable Model

S562

Drawing Title

Indoor Monitor Panel

Drawing Unit

mm

Drawing Scale

Not to scale

**DRAFT
CHANGE TO
SUBJECT**

Last Revised

Nov 22, 2023

Drawing Version

V1.0

Page

1 of 3

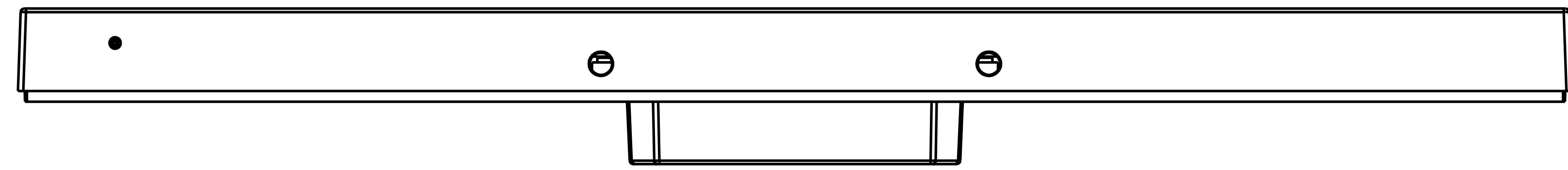

⑥ **BOTTOM VIEW**

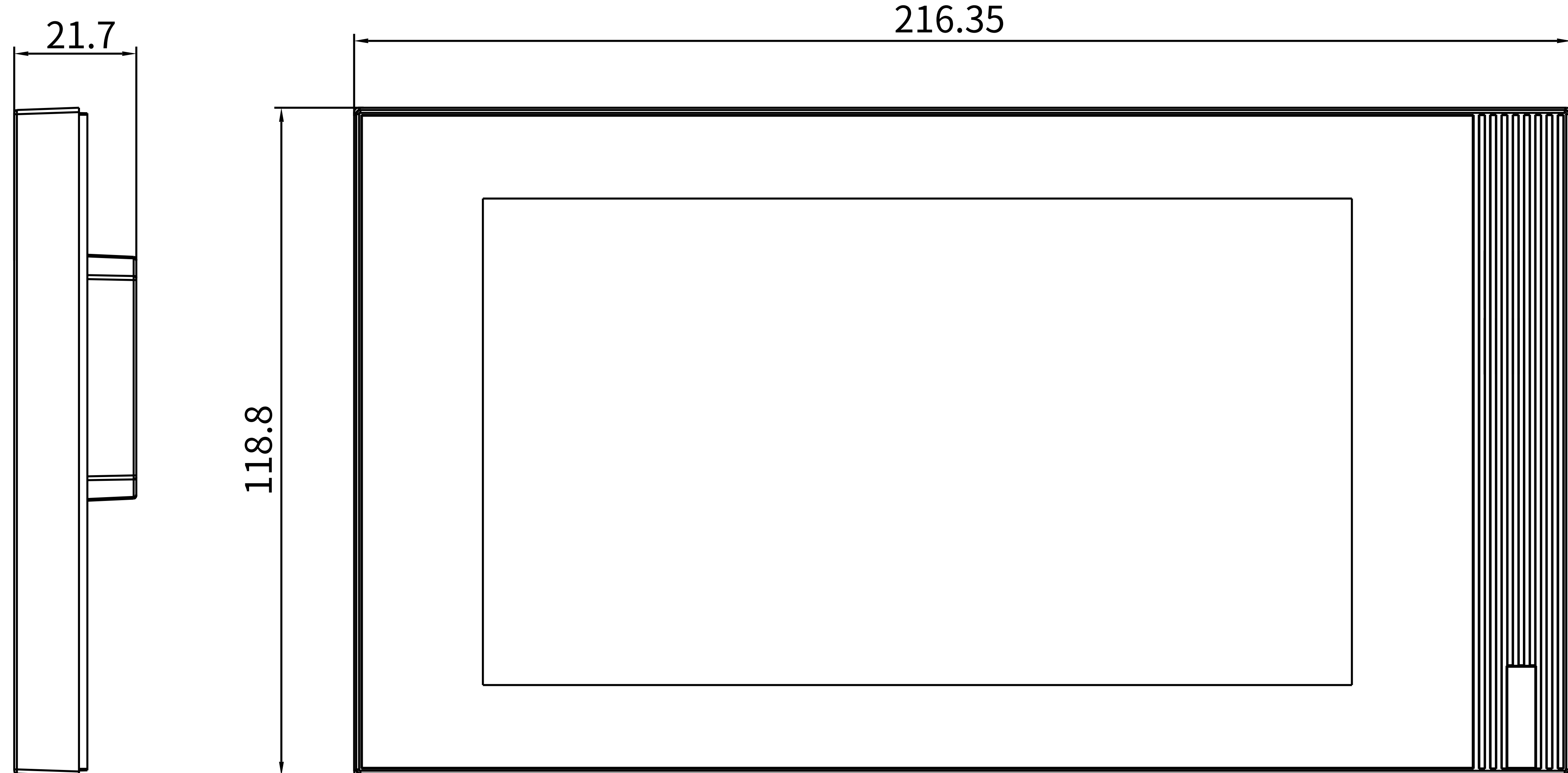

① **FRONT VIEW**

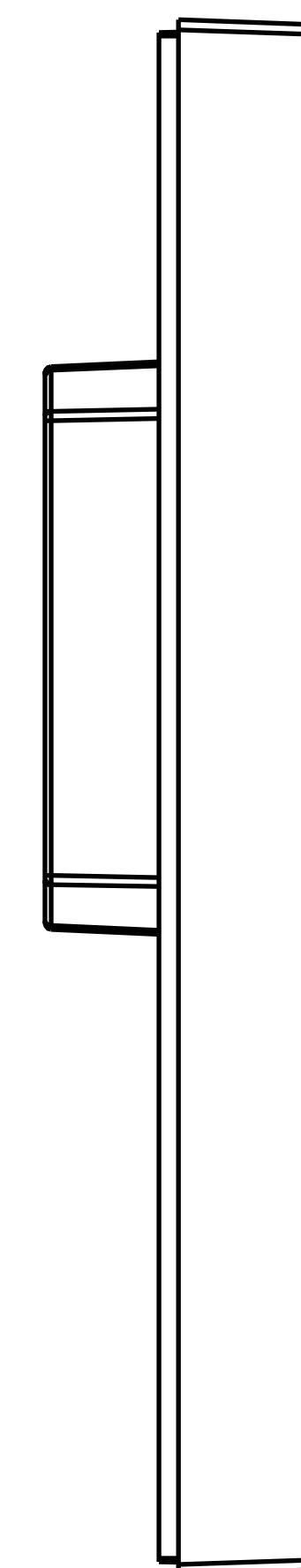

③ **LEFT VIEW**

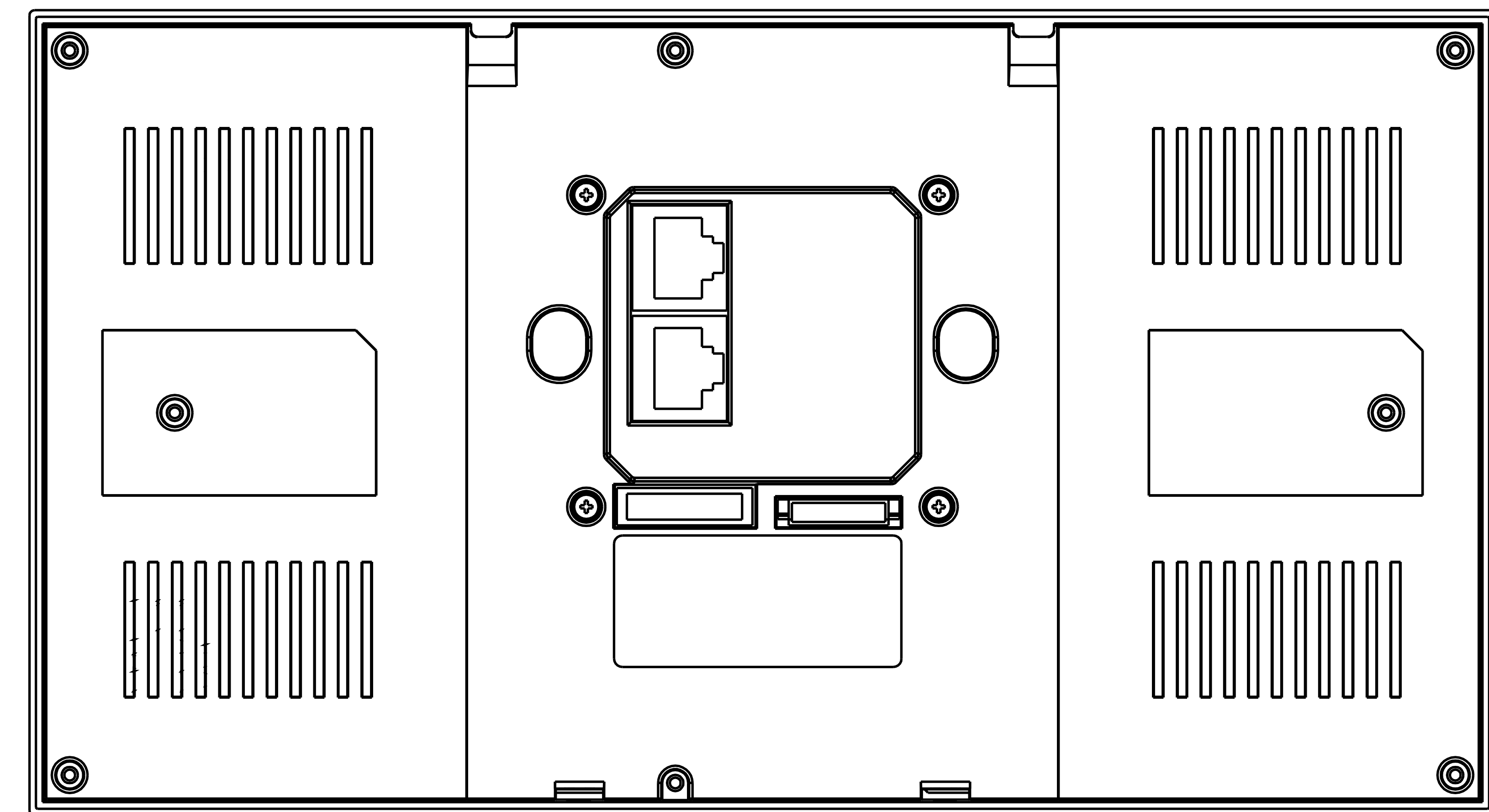

④ **BACK VIEW**

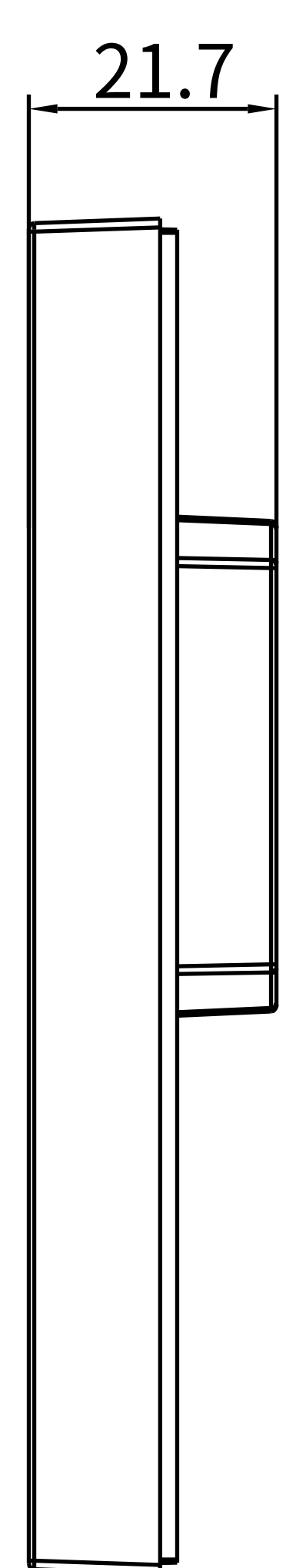

② **RIGHT VIEW**

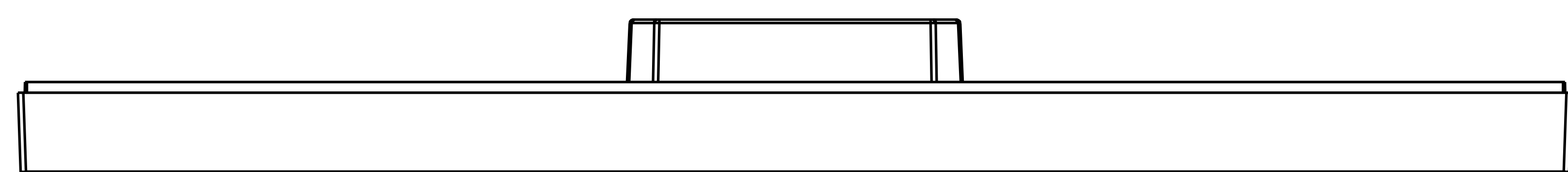

⑤ **TOP VIEW**

Applicable Model

S562

Drawing Title

Wall Mounting Bracket

Drawing Unit

mm

Drawing Scale

Not to scale

**DRAFT
SUBJECT TO
CHANGE**

Last Revised

Nov 22, 2023

Drawing Version

V1.0

Page

2 of 3

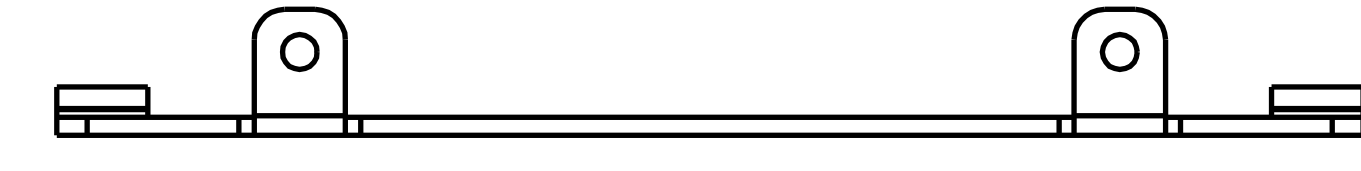

⑥ **BOTTOM VIEW**

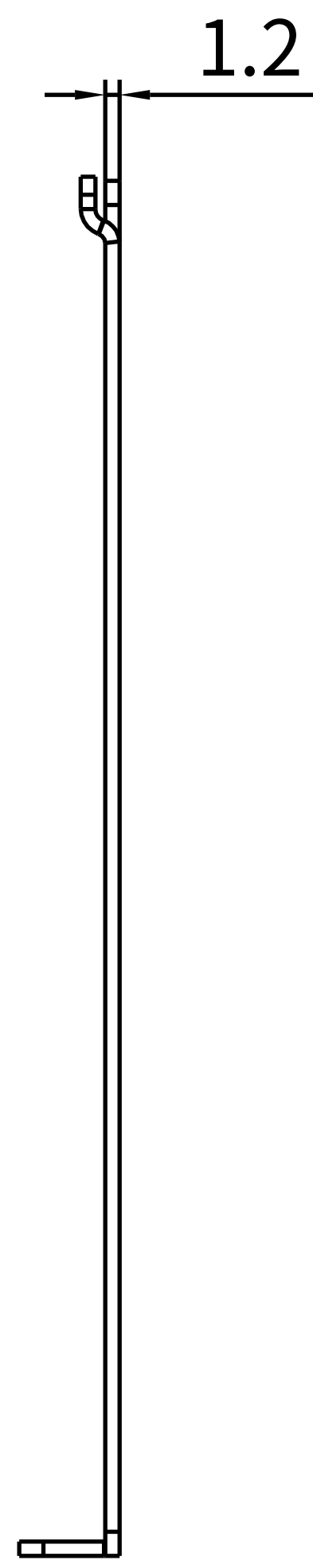

② **RIGHT VIEW**

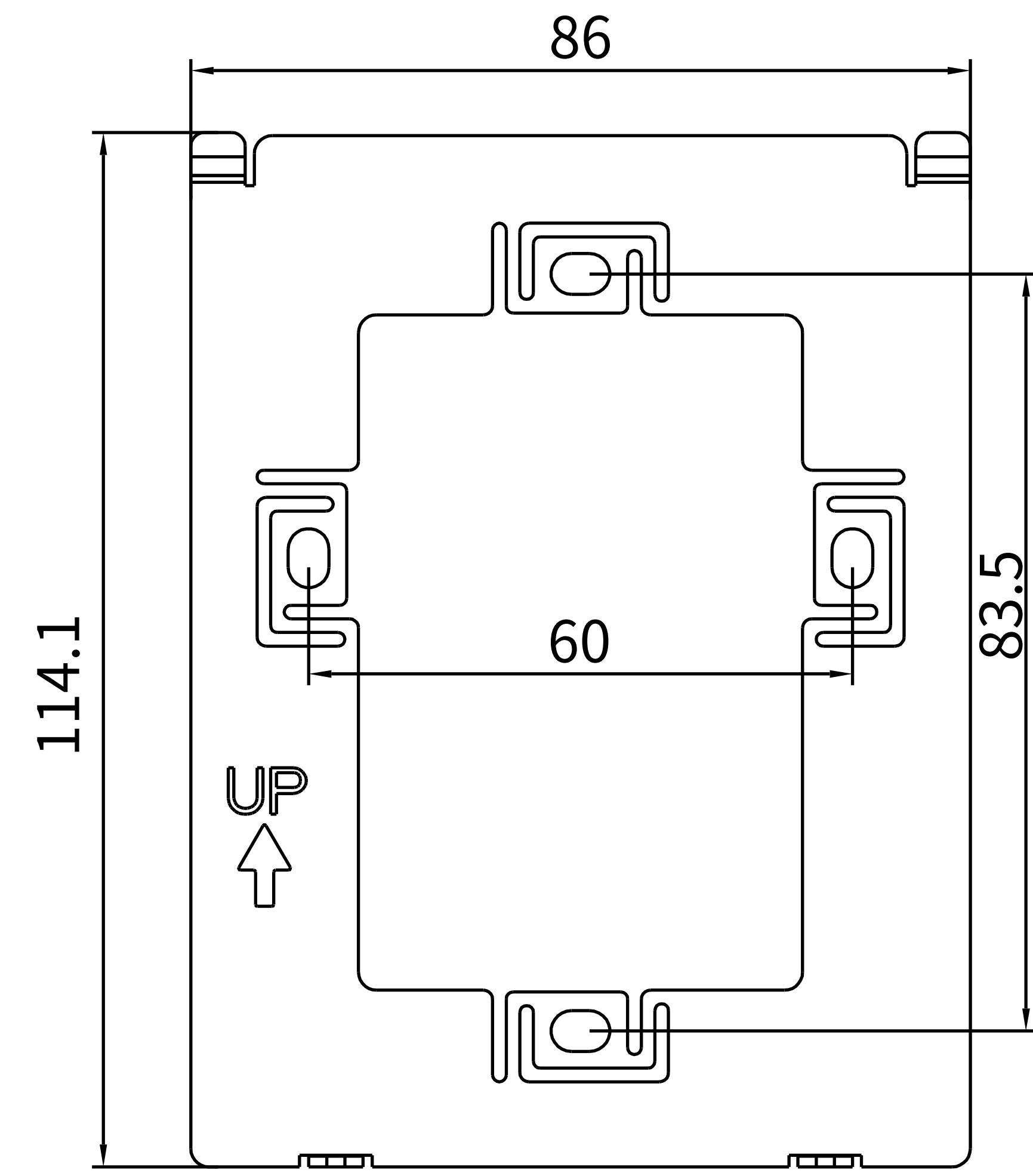

① **FRONT VIEW**

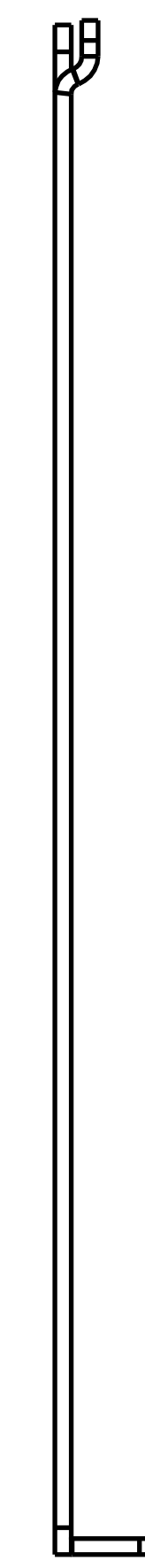

③ **LEFT VIEW**

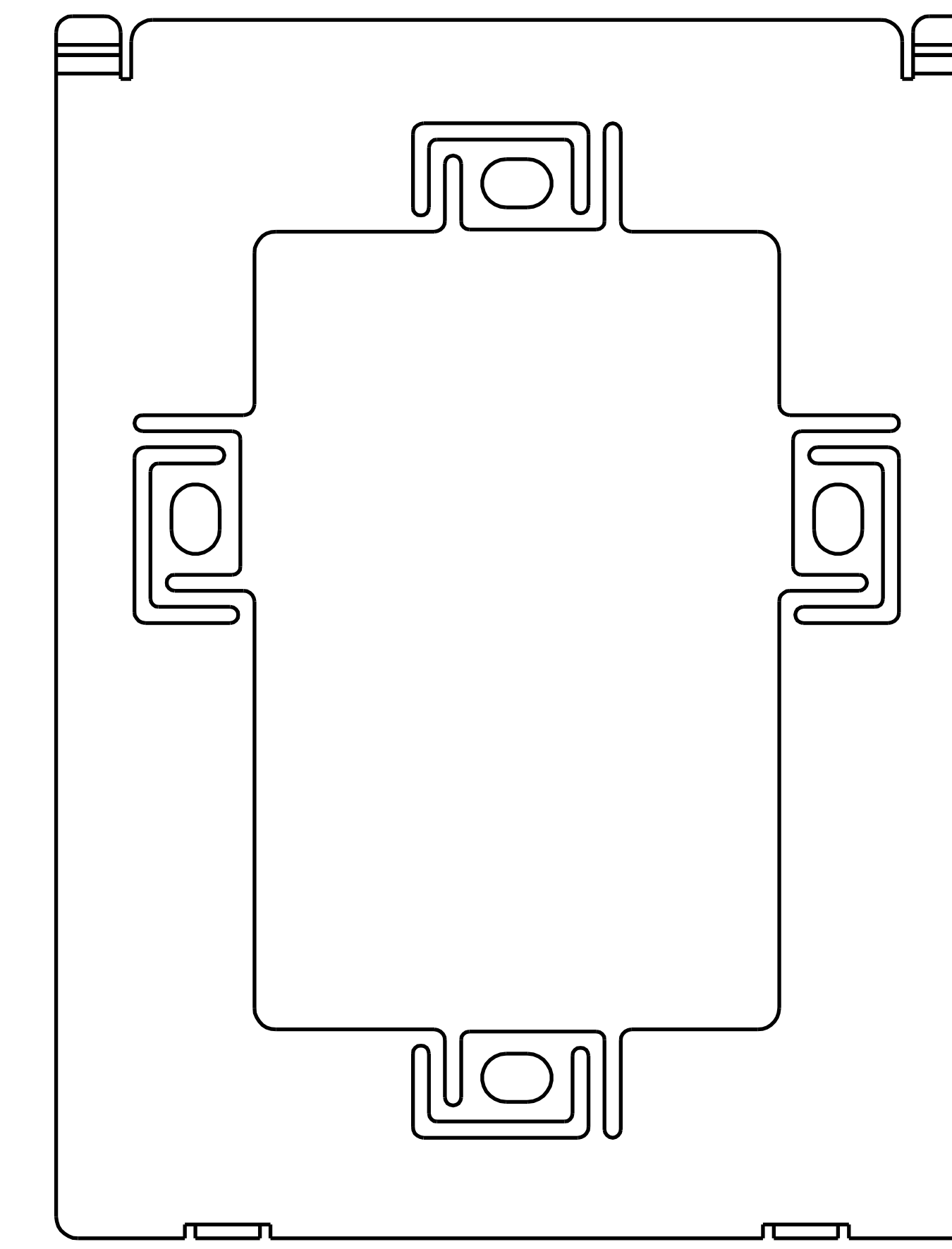

④ **BACK VIEW**

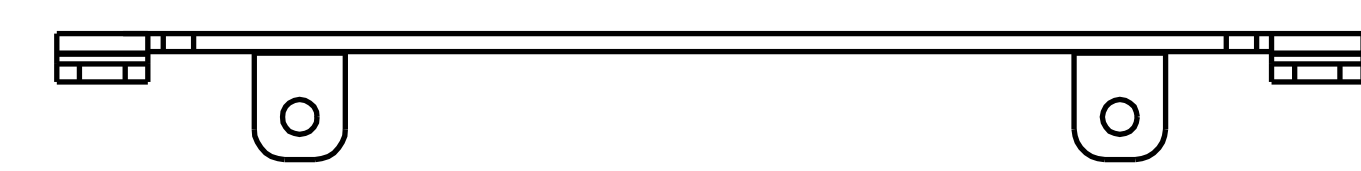

⑤ **TOP VIEW**



① INDOOR MONITOR PANEL FRONT VIEW

1080mm TO BOTTOM OF PANEL

1200mm MAX TO TOP OF PANEL

ADA Compliance Requirement

GROUND

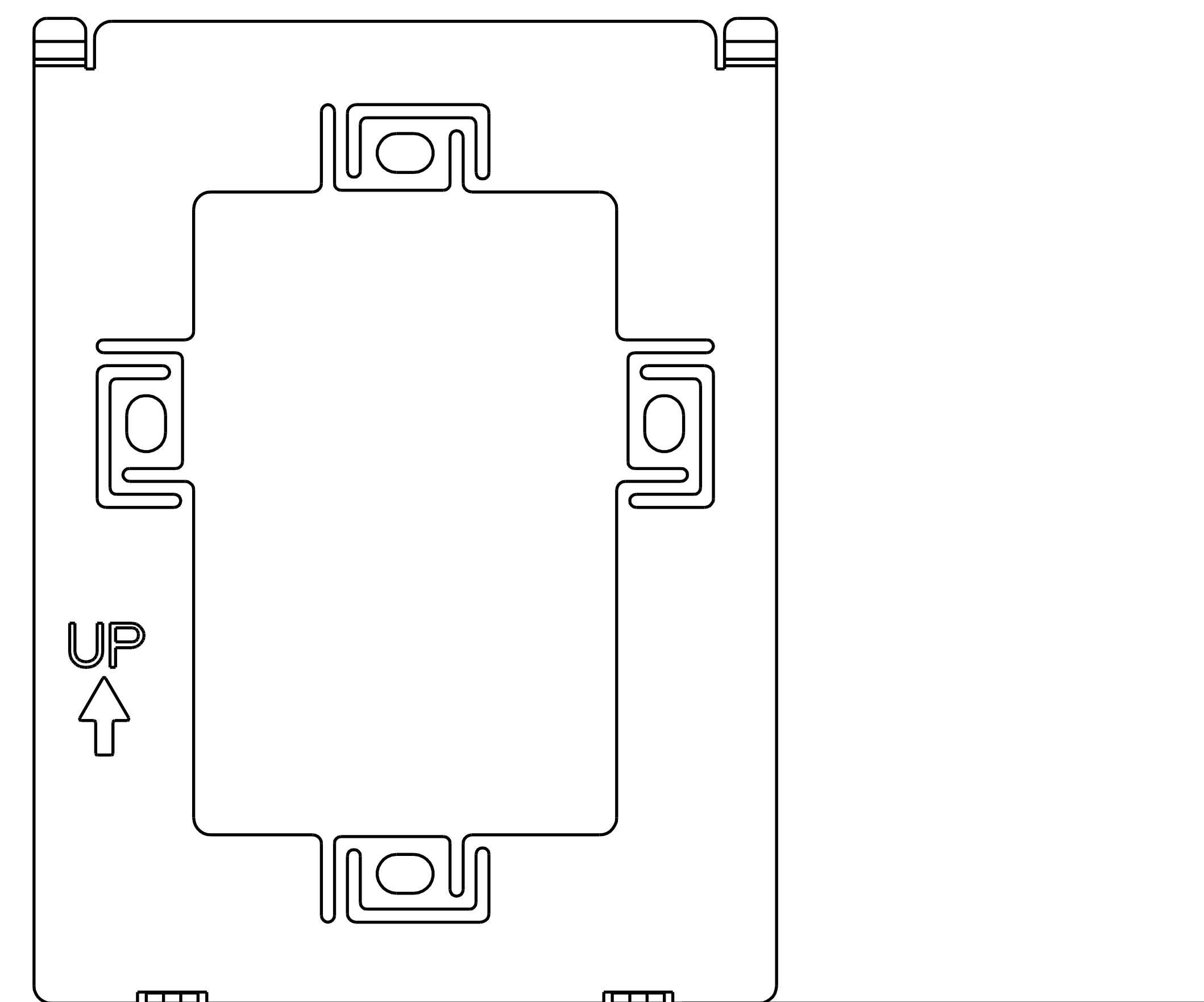

② FRONT VIEW:WALL MOUNTING BRACKET PLACEMENT

1080mm TO BOTTOM OF BRACKET

GROUND

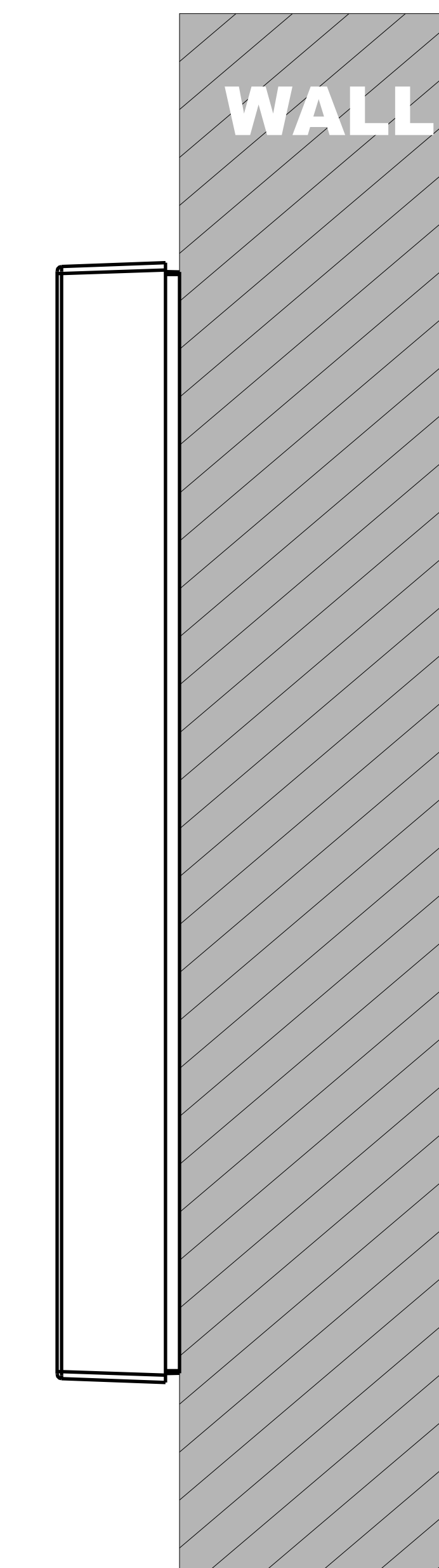

③ SIDE VIEW:INDOOR MONITOR ON WALL

**DRAFT
SUBJECT TO
CHANGE**

Last Revised

Nov 22, 2023

Drawing Version

V1.0

Page

3 of 3